



ONE STOP SHOPPING!

For users of Composite Materials

The Complete Range

Dear Business Partner,

BÜFA Composite Systems is one of the leading European developers and producers of reactive resin specialities. As the only system supplier with their own machines and equipment, we guarantee you, as a business partner, the unparalleled know-how of our engaged employees and the entire range of gelcoats, topcoats, resins, high performance adhesives, hardeners, tooling and fire protection systems for every application area. Our complete range of products are ideally supplemented by products from our premium partners.

As a family-run company with high ethical standards, new chemistry does not stop

at innovative solutions and applications but continues in our interactions with our employees, our partners and customers as well as the environment. BÜFA Composite Systems stands for sustainability, for innovation, for digitalisation of the chemical trade and for an attractive partner and employer.

360° BÜFA – here we look in all directions!

In the following pages you will find more detailed information on our wide portfolio and can decide how we can support you.

We are looking forward to hearing from you!



Lothar Kempf
Managing Director

BÜFA is a member of the following organisations:



Unsaturated Polyester Resins, Vinyl Ester Resins and Epoxy Systems

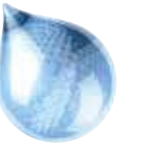

Gelcoats and Topcoats



Bonding Pastes, Fillers and High Performance Adhesives

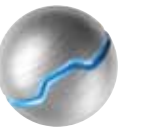

Pigment Pastes



Initiators



Release Agents, Additives and Ancillaries



Reinforcements, Core and Non-woven Materials



Fire Retardant Systems



Mould Making Systems



Machine Technology, Tools and Ancillaries





HIGH QUALITY MATRIX RESINS

UP-Resins, VE-Resins & Epoxy Systems

Composites

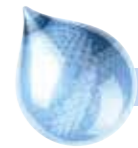

Copyright: delphiyachts.eu



Abbreviations for base resins

BPA	=	bisphenol A
VE	=	vinyl ester
VEU	=	vinyl ester urethane
EN	=	epoxy Novolac
OP	=	orthophthalic acid
IP	=	isophthalic acid
NPG	=	neopentyl glycol
MSA	=	maleic acid
AA	=	adipic acid
THP	=	tetrahydrophthalic acid
DCPD	=	dicyclopentadiene
LSE	=	low styrene emission
TP	=	terephthalic acid
PG	=	propylene glycol

Unsaturated Polyester Resins, Vinyl Ester Resins and Epoxy Systems

Unsaturated Polyester Resins and Vinyl Ester Resins

Unsaturated polyester resins and vinyl ester resins are the most often used 'representatives' of the thermoset materials. Because they are easy to process and have very good physical properties, especially when combined with fibre reinforcement, finished products made of these polymers have become an integral part of our daily lives.

The increasingly demanding applications of our customers require products with excellent technical properties. Sustainable solutions are also increasingly coming to the fore. We offer you a large selection of environment-friendly, styrene-free systems.

Applications include the automotive, rail vehicle, wind energy and building industries, sanitary market, as well as tanks and pipes, boat construction and swimming pools.

From hand lay-up to spray lay-up or RTM processes all the way to pultrusion applications, we can always offer our customers the best possible solution from our own extensive range of products that we have developed or from the portfolio of our premium partner, Aliancys AG.

Epoxy Resin Systems

In the area of epoxy resins there are numerous possibilities. New demands on the matrix, led by continuous progress in composite technology, are common today. Changes in composite materials, application methods and requirements make adjustments in the resin area necessary.

BÜFA® epoxy resin systems are high quality systems and constitute a valuable part of our portfolio. Because of BÜFA's research and development capabilities, special formulations and development work to meet customer-specific requirements are always possible.

BÜFA's well-equipped laboratories, which include equipment for determining characteristic values, allow existing systems to be quickly finely adjusted. It does not present a problem, for example, to fine tune epoxy systems to meet the customer's needs when it comes to processing or even shortening production cycles. Our many years of successful research work in the field of UP and VE chemistry accelerate development because our experience and knowledge flow over into the area of EP resins, especially in the fire protection sector or, for example, the development of gelcoats and adhesives.

Low styrene and styrene-free resin systems

Resin name	Synolite 5540-X-1	Atlac Premium 100	Atlac Premium 600
Art. No.	770-5540	020-0100	612-0600
Resin base	INSERT	VE	VE
Styrene content [%]	27-28.5	styrene-free	styrene-free
Non-volatile matter [%]	71.5-73	not determined	not determined
Viscosity [mPa.s]	360-525	420-520	900-1,100
Elongation at break [%]	2.5	2.4	2.5
Tensile strength [MPa]	71	61	66
HDT [°C]	90	101	103
Curing system	1 % BÜFA-Co 1 + 1.5 % MEKP moderately reactive	2 % BÜFA-Co 1 + 2 % MEKP low reactivity	Heat curing
Gel time at 25 °C [min]	–	19	–
Comments	Wide range of use. High solid content (70 %), up to 35 % reduced styrene emission during spray-up. Corresponds to type 1140 according to DIN 16946/2, not pre-accelerated	Styrene-free laminating resin	Relining



Copyright: Europa-Park

blue fire Megacoaster powered by GAZPROM

Unsaturated Polyester Resins and Vinyl Ester Resins

Continuous laminating / Sheet production



Resin name	Palatal P 69-02	Palatal P 61-01	BÜFA®-Firestop 6806-N-5	BÜFA®-Firestop 6815-N-4	
Art. No.	020-0069	020-5018	788-0806	788-0816	
Resin base	OP	OP	OP	DCPD	
Non-volatile matter [%]	66	64	60	65	
Viscosity [mPa.s]	700	800	200	210	
Elongation at break [%]	3.4	2.4	0.6	1.9	
Tensile strength [MPa]	75	85	96	75	
HDT [°C]	90	90	63	54	
Curing system	0.4 % BÜFA-Co 1 + 1 % AAP moderately reactive	0.5 % BÜFA-Co 1 + 1 % AAP moderately reactive	0.5 % BÜFA-Co 1 + 2 % MEKP moderately reactive	0.5 % BÜFA-Co 1 + 2 % MEKP moderately reactive	
Gel time at 25 °C [min]	22	18	14	11	
Comments	Highly reactive, 1140 type, not pre-accelerated	Highly reactive, 1140 type, medium viscosity, not pre-accelerated	Halogenated resin for translucent applications, limited UV-stability, not pre-accelerated	Halogenated resin for translucent applications, limited UV-stability, not pre-accelerated	

Hand lay-up and spray-up processes

Resin name	BÜFA®-Resin UP 0426 HLU	BÜFA®-Resin VE 0044 HLU	BÜFA®-Resin UP 0101 HLU	BÜFA®-Resin UP 9090 HLU	BÜFA®-Resin UP 0102 HLU
Art. No.	700-0426	700-0044	700-0101	700-9090	700-0102
Resin base	IP	BPA/VE	IP/NPG	OP	OP
Non-volatile matter [%]	56	54	56	60	60
Viscosity [mPa.s]	1,100	1,500	1,650	1,400	500 s ⁻¹
Elongation at break [%]	4.6	6.1	2.5	2.8	2
Tensile strength [MPa]	90	95	70	90	70
HDT [°C]	93	105	107	104	63
LSE	no	no	no	yes	no
Thixotropic	yes	yes	yes	yes	yes
Curing system	2 % MEKP moderately reactive	2 % MEKP low reactivity	2 % MEKP higher reactivity	2 % MEKP moderately reactive	2 % MEKP moderately reactive
Gel time at 20 °C [min]	25	14	22	24	30
Comments	Boat construction, containers, pipes for increased chemical and mechanical loads, pre-accelerated	For high chemical, mechanical and hydrolysis loads, for sewer rehabilitation, containers and chemical industry, pre-accelerated	Boat construction, first layer of resin for hydrolysis loads, pre-accelerated	For high mechanical loads in vehicle construction, pre-accelerated	Boat construction, wets fibres quickly, low exothermic character, also for thick laminates, GL approval, pre-accelerated

Unsaturated Polyester Resins and Vinyl Ester Resins

Hand lay-up and spray-up processes

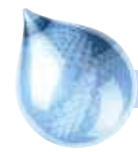

Resin name	Synolite 8388-P-1	Palatal P 4 TV-28	Palatal U 541 TV-08	Palatal U 569 TV-01	Palatal U 570 TV-01	Palatal U 570 TV-04
Art. No.	770-8388	020-5009	020-5418	020-0569	020-8905	020-0570
Resin base	DCPD	OP	OP	OP	OP	OP
Non-volatile matter [%]	62	55	56	58	56	53
Viscosity [mPa.s]	315.20	335	220	385	480	400
Elongation at break [%]	2.2	2	2	3.4	2.4	2.4
Tensile strength [MPa]	70	70	70	75	80	80
HDT [°C]	85	63	62	90	90	90
LSE	yes	no	yes	yes	yes	yes
Thixotropic	yes	yes	yes	yes	yes	yes
Curing system	2 % MEKP moderately reactive	1 % MEKP moderately reactive	2 % MEKP moderately reactive	1.5 % MEKP moderately reactive	1.5 % MEKP moderately reactive	1.5 % MEKP moderately reactive
Gel time at 25 °C [min]	24	32	21	25	23	25
Comments	Wets fibres and fillers quickly, peroxide indicator, DNV approval, pre-accelerated	Medium gel time, low exothermic character in thick laminates, pre-accelerated, Lloyd's approval, 1110 type	General use, low Tmax, medium to long gel time, pre-accelerated, Lloyd's approval, 1120 type	Boat construction, fast impregnation, pre-accelerated, for thin laminates, 1140 type	Wide range of use, good mechanical properties, pre-accelerated, 1140 type	Wide range of use, good mechanical properties, low exothermic character, pre-accelerated, 1140 type

Resin name	BÜFA®-Resin UP 0069 HLU	BÜFA®-Resin UP 0113 ACR	BÜFA®-Resin UP 0424 HLU	BÜFA®-Resin UP 0425 HLU	BÜFA®-Resin UP 0117 ACR
Art. No.	700-0069	700-0113	700-0424	700-0425	700-0117
Resin base	OP	OP	IP/NPG	IP	OP
Non-volatile matter [%]	57	75	50	58	80
Viscosity [mPa.s]	1,000	2,500	1,350	1,500	2,250
Elongation at break [%]	3.4	2	4.4	4.6	2
Tensile strength [MPa]	75	70	85	90	70
HDT [°C]	90	63	107	93	63
LSE	no	yes	no	no	Ja
Thixotropic	yes	yes	yes	yes	Ja
Curing system	2 % MEKP moderately reactive	2 % MEKP moderately reactive	1 % BÜFA-Co 1 + 2 % MEKP/AAP mixture moderately reactive	1 % BÜFA-Co 1 + 2 % MEKP moderately reactive	2 % MEKP moderately reactive
Gel time at 20 °C [min]	29	25	13	62	
Comments	Profiles, pipes and containers as well as boat and vehicle construction, pre-accelerated	PMMA reinforcement, white, pre-accelerated	Boat construction, for high chemical and hydrolysis loads, not pre-accelerated	Boat construction, containers, pipes for increased chemical and mechanical loads, mould-making, not pre-accelerated	PMMA reinforcement, white, pre-accelerated

Unsaturated Polyester Resins and Vinyl Ester Resins

RTM/ resin infusion /vacuum injection

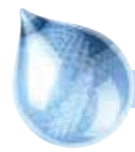

Resin name	Synolite 1967-G-3	Synolite 8488-G-2	Palatal P 80-02	Daron 45
Art. No.	770-1969	770-8488	020-0080	780-4502
Resin base	DCPD	DCPD	OP	VEU Hybrid
Non-volatile matter [%]	63	57	63	69
Viscosity [mPa.s]	170	85	345	200
Elongation at break [%]	2.2	3	4.2	2.5
Tensile strength [MPa]	70	66	80	70
HDT [°C]	85	64	108	220
Curing system	3 % MEKP moderately reactivity	3 % MEKP moderately reactivity	0.5 % BÜFA-Co 1 + 1 % AAP moderately reactivity	2 % BÜFA-DEA 10 + 2 % BPO-50
Gel time at 25 °C [min]	45	47	16	23
Comments	Wets quickly, improved surface quality, DNV approval for light sport boats, pre-accelerated	Very low viscosity for especially fast wetting, low exothermic character, pre-accelerated	Highly reactive resin, not pre-accelerated, 1140 type	Very high resistance to temperature and chemicals, very good compatibility with glass and carbon fibres, not pre-accelerated

Resin name	BÜFA®-Resin UP 0103 RTM	BÜFA®-Resin VE 4360 RTM	BÜFA®-Resin UP 6668 RTM	BÜFA®-Resin UP 423 RTM
Art. No.	700-0103	700-4360	700-6668	710-0423
Resin base	OP	BPA/VE	OP	OP
Non-volatile matter [%]	50	58	62	55
Viscosity [mPa.s]	440	250	500	160
Elongation at break [%]	2	6.1	4.2	4.2
Tensile strength [MPa]	70	95	80	80
HDT [°C]	63	105	90	108
Curing system	2 % MEKP moderately reactive	2 % MEKP moderately reactive	2 % MEKP low reactivity	0.4 % BÜFA-Co 1 + 1 % MEKP moderately reactivity
Gel time at 25 °C [min]	33 (at 20 °C)	48	52 (at 20 °C)	16
Comments	Especially developed for marine applications in a VI process, pre-accelerated	For the production of high quality moulded parts with excellent mechanical properties which must have high chemical resistance. Excellent long-term heat resistance as well as high resistance to dynamic loads, pre-accelerated	Especially developed for applications in vehicle construction for VI and RTM processes, pre-accelerated	High reactivity, low viscosity, not pre-accelerated

Unsaturated Polyester Resins and Vinyl Ester Resins

Chemically resistant applications

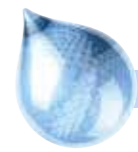

Resin name	Palatal A 410-01	Atlac 430	Atlac 580 ACT	Atlac 590	Atlac E-nova FW 1045	Atlac E-nova FW 2045
Art. No.	020-0410	020-0430	780-5800	780-0590	780-1045	780-2719
Resin base	IP/NPG	BPA/VE	BPA/VEU	EN/VE	BPA/VEU	BPA/VEU
Non-volatile matter [%]	57	62	51	64	60	60
Viscosity [mPa.s]	1,200	470	550	250	400	425
Elongation at break [%]	4.4	6.1	4.2	4.0	5-6	3.5
Tensile strength [MPa]	85	95	83	90	85	90
HDT [°C]	107	105	115	140	125	145
Curing system	0.5 % BÜFA-Co 1 + 1 % AAP moderately reactive	1 % BÜFA-Co 1 + 1 % MEKP low reactivity	1.5 % MEKP moderately reactive	1 % BÜFA-Co 1 + 2 % MEKP low reactivity	3 % BÜFA-Co 1 + 2 % MEKP moderately reactive	3 % BÜFA-Co 1 + 2 % MEKP moderately reactive
Gel time at 25 °C [min]	12	13	29	34	25	20
Comments	High chemical resistance, tanks, pipes, adheres to PVC, not pre-accelerated, 1140 type	High resistance to temperature and chemicals, not pre-accelerated, 1310 type	High resistance to temperature and chemicals, pre-accelerated, thixotropic	High resistance to temperature and chemicals, not pre-accelerated, 1310 type	High resistance to temperature and chemicals, not pre-accelerated	High resistance to temperature and chemicals, not pre-accelerated

Resin name	Atlac E-nova MA 6325	BÜFA®-Resin UP 0424 HLU	BÜFA®-Resin VE 0052	BÜFA®-Resin VE 0597 HLU	BÜFA®-Resin VE 4360 RTM	BÜFA®-Resin VE 262 Conductive
Art. No.	780-6325	700-0424	700-0052	700-0597	700-4360	700-0262
Resin base	BPA/VEU	IP/NPG	BPA/VE	EN/VE	BPA/VE	BPA/VEU
Non-volatile matter [%]	66	50	58-60	60-62	58	64
Viscosity [mPa.s]	1,500	1,350	1,600	900	250	1,400
Elongation at break [%]	2-3	4.4	6.1	4.0	6.1	2-3
Tensile strength [MPa]	70	85	95	90	95	80
HDT [°C]	110	107	105	140	105	145
Curing system	1.5 % MEKP moderately reactive	1 % BÜFA-Co 1 + 2 % MEKP-AAP-mixture, moderately reactive	0.8 % BÜFA-Co 1 + 2 % MEKP low reactivity	2 % MEKP low reactivity	2 % MEKP moderately reactive	1.5 % MEKP moderately reactive
Gel time at 25 °C [min]	28	13 (at 20 °C)	18 (at 20 °C)	20 (at 20 °C)	48	15
Comments	Boat construction, swimming pool construction, for high chemical and hydrolytic loads, thixotropic, pre-accelerated	Boat construction, for high chemical and hydrolytic loads, thixotropic, not pre-accelerated	Boat construction, for high chemical and hydrolytic loads. For sewer rehabilitation, containers and chemical industry, not pre-accelerated	High resistance to temperature and chemicals, pre-accelerated	For the production of high quality moulded parts with excellent mechanical properties which must have high chemical resistance. Excellent long-term heat resistance as well as high resistance to dynamic loads, pre-accelerated	Conductive, highly resistant to temperature and chemicals, pre-accelerated

Unsaturated Polyester Resins and Vinyl Ester Resins

Casting applications and filled systems



Resin name	BÜFA®-Resin UP 0105 CST	BÜFA®-Resin UP 0259 CST	BÜFA®-Resin UP 0804 CST	BÜFA®-Resin UP 0001 CST	BÜFA®-Resin UP 0020 CST
Art. No.	700-0105	700-0259	700-0804	700-0001	700-0020
Resin base	OP	flexible UP resin	OP/IP highly flexible	OP flexible	OP
Non-volatile matter [%]	63	79	62	62	61
Viscosity [mPa.s]	850	1,900	500	2,000	2,000
Elongation at break [%]	2	not determined	not determined	> 10	> 10
Tensile strength [MPa]	70	not determined	not determined	not determined	not determined
HDT [°C]	63	not determined	not determined	30	RT
LSE	no	no	no	no	no
Thixotropic	no	no	no	yes	yes
Curing system	0.5 % BÜFA-Accelerator Complex + 2 % MEKP/AAP-mixture, moderately reactive	2 % MEKP moderately reactive	2 % MEKP moderately reactive	1 % MEKP moderately reactive	2 % MEKP moderately reactive
Gel time at 20 °C [min]	8	8	19	22	10
Comments	Polymer concrete, not pre-accelerated	Wide range of use, potting compound, pre-accelerated	For pouring transparent ornaments, pre-accelerated	Suitable for pouring furniture ornaments, door fillings, wood imitation, etc. light-weight, pre-accelerated	Suitable for pouring furniture ornaments, door fillings, wood imitation, etc. light-weight, elastic, pre-accelerated

Resin name	Synolite 0328-A-1	Palatal P 61-02	Palatal P 4-01 FC	Palatal P 5-01
Art. No.	770-0328	020-5755	020-0004	020-0005
Resin base	OP	OP	OP	OP
Non-volatile matter [%]	64	60	63	64
Viscosity [mPa.s]	490	350	580	750
Elongation at break [%]	1.6	2	2	2.2
Tensile strength [MPa]	56	65	70	70
HDT [°C]	55	85	63	64
LSE	no	no	no	no
Thixotropic	no	no	no	no
Curing system	1 % MEKP moderately reactive	0.5 % BÜFA-Co 1 + 1 % MEKP moderately reactive	0.4 % BÜFA-Co 1 + 1 % AAP moderately reactive	0.4 % BÜFA-Co 1 + 1 % AAP moderately reactive
Gel time at 25 °C [min]	21	22	20	20
Comments	Clear casting resin with little colour, low reactivity, pre-accelerated, also for use as an embedding resin	Polymer concrete, low viscosity, highly reactive, not pre-accelerated, 1140 type	Wide range of use, for polymer concrete and synthetic marble, not pre-accelerated, Lloyd's approval, 1110 type	Wide range of use, for glass fibre reinforced moulded parts with good mechanical properties, not pre-accelerated, 1120 type

Unsaturated Polyester Resins and Vinyl Ester Resins

Mould making resins

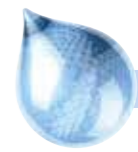

Product name	BÜFA®-Resin UP 1974 Tooling	Atlac 580 ACT	BÜFA®-Resin VEU 1978 Tooling
Art. No.	700-1974	780-5800	700-1978
Application	hand lay-up and spray-up	hand lay-up	hand lay-up
Resin base	DCPD	BPA/VEU	BPA/VEU
Viscosity [mPa.s] – Spindle/rpm	1,150 -3/20	1,300	1,500 -3/20
Styrene content [%]	35	49	41
Peroxide / accelerator	2.0 % MEKP medium reactive, pre-accelerated	2.0 % MEKP medium reactive, pre-accelerated	2.0 % MEKP medium reactive + 0.5 % BÜFA-Accelerator Complex, not pre-accelerated
Gel time [min]	42	30	32
Tmax [°C]	120	140	185
Tensile strength [MPa]	47	83	90
Tensile E-modulus [MPa]	5.6	3.5	3.5
Elongation at break [%]	1.8	4.2	3-4
HDT [°C]	80	115	145
Range of use / comments	GRP tooling. Practically shrink-free laminating resin with an LP additive	GRP tooling. Laminating resin for the first layer of glass	GRP tooling. Laminating resin for high temperature moulds up to 130 °C, construction of max. 2 layers of glass in one working operation

Compression moulding

Resin name	Palatal P 4-01 FC	Palatal P 5-01	Palatal P 61-01	Palatal P 61-02	Atlac 590
Art. No.	020-0004	020-0005	020-5018	020-5755	780-0590
Resin base	OP	OP	OP	OP	EN/VE
Non-volatile matter [%]	63	64	64	60	64
Viscosity [mPa.s]	580	750	800	350	245
Elongation at break [%]	2	2.2	2.4	2.8	4.0
Tensile strength [MPa]	70	70	85	85	90
HDT [°C]	63	64	90	90	140
Curing system	0.4 % BÜFA-Co 1 + 1 % AAP moderately reactive	0.4 % BÜFA-Co 1 + 1 % AAP moderately reactive	0.5 % BÜFA-Co 1 + 1 % AAP moderately reactive	0.5 % BÜFA-Co 1 + 1 % MEKP moderately reactive	1 % BÜFA-Co 1 + 2 % MEKP low reactivity
Gel time at 25 °C [min]	20	20	18	18	34
Comments	Wide range of use, not pre-accelerated, Lloyd's approval, 1110 type	Wide range of use, for glass fibre reinforced moulded parts with good mechanical properties, not pre-accelerated, 1120 type	Highly reactive, medium viscosity, 1140 type, not pre-accelerated	Polymer concrete, low viscosity, highly reactive, not pre-accelerated	High resistance to chemicals and high temperature, not pre-accelerated, 1310 type

Unsaturated Polyester Resins and Vinyl Ester Resins

Filament winding processes



Resin name	Palatal A 400-01	Palatal A 410-01	Palatal P 4-01 FC	Palatal P 69-02	Atlac 382 (A)	Atlac 430
Art. No.	020-5507	020-0410	020-0004	020-0069	780-0382	020-0430
Resin base	IP	IP/NPG	OP	OP	BPA	BPA/VE
Non-volatile matter [%]	65	57	63	66	50	62
Viscosity [mPa.s]	1,000	1,200	580	700	610	470
Elongation at break [%]	4.6	4.4	2	3.4	2.1	6.1
Tensile strength [MPa]	90	85	70	75	62	95
HDT [°C]	93	107	63	90	120	105
Curing system	0.5 % BÜFA-Co 1 + 1 % MEKP moderately reactive	0.5 % BÜFA-Co 1 + 1 % AAP moderately reactive	0.4 % BÜFA-Co 1 + 1 % AAP moderately reactive	0.4 % BÜFA-Co 1 + 1 % AAP moderately reactive	2 % BÜFA-DMA 10 + 0.75 % BÜFA-Co 6 + 0.65 % TBC 10% + 1.2 % MEKP moderately reactive	1 % BÜFA-Co 1 + 1 % MEKP low reactivity
Gel time at 25 °C [min]	17	12	20	22	24	13
Comments	Tanks and containers, highly reactive, 1140 type, not pre-accelerated, Lloyd's approval	Resistant to chemicals, adheres to PVC, 1140 type, not pre-accelerated	Low reactivity, not pre-accelerated, Lloyd's approval, 1110 type	Highly reactive, 1140 type, not pre-accelerated	Resistant to chemicals	Highly resistant to chemicals and thermal loads, not pre-accelerated, 1310 type

Resin name	Atlac 580	Atlac 590	Atlac-E-nova FW 1045	Atlac E-nova FW 2045	BÜFA®-DCPD Harz 0251	BÜFA®-Winding Resin 0253
Art. No.	780-0580	780-0590	780-1045	780-2719	716-0251	716-0253
Resin base	BPA/VEU	EN/VE	BPA/VEU	BPA/VEU	DCPD	OP
Non-volatile matter [%]	53	64	60	60	70	58
Viscosity [mPa.s]	450	250	400	425	900	850
Elongation at break [%]	4.2	4.0	5-6	3.5	3	2.5
Tensile strength [MPa]	83	90	85	90	70	75
HDT [°C]	115	140	125	145	95	90
Curing system	2.5 % BÜFA-Co 1 + 1 % BÜFA-Co 6 + 1 % MEKP moderately reactive	1 % BÜFA-Co 1 + 2 % MEKP low reactivity	3 % BÜFA-Co 1 + 2 % MEKP moderately reactive	3 % BÜFA-Co 1 + 2 % MEKP moderately reactive	2 % MEKP moderately reactive	2 % MEKP moderately reactive
Gel time at 25 °C [min]	38	34	25	20	17 (at 20 °C)	16 (at 20 °C)
Comments	High chemical and thermal resistance, not pre-accelerated	High chemical and thermal resistance, not pre-accelerated, 1310 type	High chemical and thermal resistance, not pre-accelerated	High chemical and thermal resistance, not pre-accelerated	ATH filled system for fire protected components, pre-accelerated	ATH filled system for fire protected components, pre-accelerated

Unsaturated Polyester Resins and Vinyl Ester Resins

Pultrusion processes

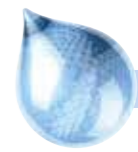

Resin name	Synolite 0175-N-1	Palatal P 6-01	Palatal P 69-02	Palatal P 51-01	Palatal A 400-01
Art. No.	770-1751	020-0006	020-0069	020-0051	020-5507
Resin base	DCPD	OP	OP	THP	IP
Non-volatile matter [%]	60	65	66	65	65
Viscosity [mPa.s]	380	1,050	700	1,000	1,000
Elongation at break [%]	2.5	2.8	3.4	7	4.6
Tensile strength [MPa]	60	90	75	75	90
HDT [°C]	95	104	90	84	93
Curing system	2 % BPO-50	0.4 % BÜFA-Co 1 + 1 % AAP moderately reactive	0.4 % BÜFA-Co 1 + 1 % AAP moderately reactive	0.5 % BÜFA-Co 1 + 1 % AAP moderately reactive	0.5 % BÜFA-Co 1 + 1 % MEKP moderately reactive
Gel time at 25 °C [min]	8 (at 82 °C)	21	22	14	17
Comments	Highly reactive, excellent filler tolerance and easily pigmented, improved surface quality, not pre-accelerated	Highly reactive resin, 1140 type, not pre-accelerated	Highly reactive resin, 1140 type, not pre-accelerated	Very good surface cure, not pre-accelerated, 1140 type,	Highly reactive resin, 1140 type, not pre-accelerated, Lloyd's approval

Resin name	BÜFA®-Firestop S 520-NV	Palapreg H 1080-01	Daron 45	Palapreg P 17-02
Art. No.	716-0521	770-1080	780-4502	020-0017
Resin base	DCPD	thermoplastic	VEU hybrid	OP
Non-volatile matter [%]	71	39	69	65
Viscosity [mPa.s]	750	4,500	200	1,400
Elongation at break [%]	2.8	not determined	2.5	1.7
Tensile strength [MPa]	82	not determined	70	60
HDT [°C]	100	not determined	220	140
Curing system	0.2 % BÜFA-FR 9 + 2 % MEKP moderately reactive	not determined	2 % BÜFA-DEA 10 + 2 % BPO-50	not determined
Gel time at 25 °C [min]	40	not determined	23	not determined
Comments	ATH filled, not pre-accelerated	LP additive for SMC, not pre-accelerated	Very high resistance to temperature and chemicals, highly compatible with glass and carbon fibres, not pre-accelerated	Highly resistant to temperature, highly reactive resin for good surface quality with LS additive or LP additive

Unsaturated Polyester Resins and Vinyl Ester Resins

Further special applications

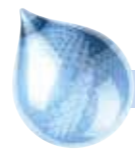

Resin name	Palatal P 51-01	Palatal E 240-02	Palatal K 775 V-2	BÜFA®-Resin UP 0410 I
Art. No.	020-0051	020-2402	020-0775	700-0410
Resin base	THP	THP	BPA/VE	IP/NPG
Non-volatile matter [%]	64-67	60-63	61	52
Viscosity [mPa.s]	900-1,100	300-370	450	850
Elongation at break [%]	7	75	6.1	4.4
Tensile strength [MPa]	75	19	95	85
HDT [°C]	84	not determined	105	107
Curing system	0.5 % BÜFA-Co 1 + 1 % AAP moderately reactive	1 % BÜFA-Co 1 + 1 % AAP moderately reactive	2 % BPO-50	UV-curing
Gel time at 25 °C [min]	14	28	7	3 (BÜFA method)
Comments	Not pre-accelerated resin for mixing with very good surface curing, BPO carrier in 2-component systems for filling, 1140 type	Not pre-accelerated, flexible resin for sprayed filling compounds with a Co-CHP curing system, for filling	Dowel resin with high resistance to chemicals, pre-accelerated	Chemical resistant, UV-curing



Copyright: Weber Kunststofftechnik

Unsaturated Polyester Resins and Vinyl Ester Resins

Halogen free resins

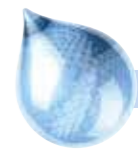

Resin name	BÜFA®-Firestop S 425	BÜFA®-Firestop S 430	BÜFA®-Firestop S 520	BÜFA®-Firestop S 555	BÜFA®-Firestop S 570	BÜFA®-Firestop S 900 Foaming Resin
Art. No.	716-0425	716-0430	716-0520	716-0555	716-0570	716-0900
Resin base	DCPD	DCPD	DCPD	DCPD	OP	OP
Non-volatile matter [%]	56	78	74	69	84	70
Viscosity [mPa.s]	230 (20s/1)	720 (20s/1)	800	750	900	1250
Elongation at break [%]	not determined	not determined	2.8	not determined	2	1.8
Tensile strength [MPa]	not determined	not determined	82	not determined	82	58
HDT [°C]	110	110	100	100	88	78
Comments	Unfilled, halogen-free, pre-accelerated, for structural components in vacuum injection processes	Halogen free filled resin system, HLU, most suitable for FSU-applications, pre-accelerated	Injection resins, ATH filled for structural components, pre-accelerated	Injection resin, ATH filled, pre-accelerated	ATH filled resin for structural components, pre-accelerated	Slightly filled, foaming resin

Resin name	BÜFA®-Firestop 5001-W-2	BÜFA®-Firestop 5001-T-1	BÜFA®-Firestop 8175-W-1
Art. No.	716-5002	716-5003	716-8175
Resin base	DCPD	DCPD	DCPD
Non-volatile matter [%]	80	not determined	76
Viscosity [mPa.s]	1100 (20s/1)	100	750 (20s/1)
Elongation at break [%]	2.2	0.45 (filled)	3
Tensile strength [MPa]	87	51 (filled)	80
HDT [°C]	90	not determined	> 100
Comments	Highly ATH filled, thixotropic resin, for higher standards, pre-accelerated	Pecial modified resin, enable up to 300 pats ATH, little smoke, not pre-accelerated	Filled, thixotropic resin for structural components, pre-accelerated



Halogenated resins

Resin name	BÜFA®-Firestop S 810	BÜFA®-Firestop 2754-P-2	BÜFA®-Firestop 2777-P-1	BÜFA®-Firestop 6806-N-5	BÜFA®-Firestop 6815-N-4	BÜFA®-Firestop S 840
Art. No.	716-0810	716-2754	716-2777	788-0806	788-0816	788-0840
Resin base	DCPD	OP	DCPD	OP	DCPD	ISO
Non-volatile matter [%]	82	65	68	60	65	60
Viscosity [mPa.s]	500 (250s/1)	230 (20s/1)	420 (20s/1)	200	210	not determined
Elongation at break [%]	not determined	1.8	1.2	0.6	1.9	>100
Tensile strength [MPa]	not determined	49	25	96	75	5
HDT [°C]	not determined	65	50	63	54	35
Comments	ATH filled and halogenated HLU resin for highest fire protection, pre-accelerated	Halogenated resin for HLU- and RTM-applications, pre-accelerated. Also available as a filled version	Halogenated resin for HLU-applications, pre-accelerated. IMO 1006 for life boats.	Halogenated resins for translucent applications, not pre-accelerated	Halogenated resins for translucent applications with highest FR-standards, not pre-accelerated	Halogenated, highly flexible resin for eg. Roofing applications, not pre-accelerated. Also available as a styrene free version (788-0842)



HIGH GLOSS SURFACE

Gelcoats & Topcoats



BÜFA®-Gelcoats

- BÜFA®-Gelcoats are intensively tested in-house with colorimetric measurements. The usual difference in the shade of colour lies in a very narrow range, depending on batch. In spite of this, only one batch should be used for the same GRP component, if possible.
- BÜFA®-Gelcoats are delivered ready to use. The addition of any additives changes the characteristics of the gelcoat and the working quality described in the technical information sheet.
- BÜFA®-Gelcoats are preaccelerated as a rule. Desired differences in gel time are controlled by the peroxide that is used. Please get in touch with our technical service concerning the selection of a suitable curing system.
- BÜFA®-Gelcoats are mostly guaranteed for a shelf-life of 3 months at room temperature. Protect containers from frost and high temperatures. Before using, stir the contents of each container carefully. Gelcoats should be visually examined upon delivery or at the latest before they are used, also checking pot-life, viscosity and colours if necessary to make sure they meet specifications. The characteristics of the gelcoat are described in the respective technical information sheets.
- BÜFA®-Gelcoats used for mould making have special working instructions which are found in the respective technical information sheet.

- If you need any help selecting the right BÜFA®-Gelcoats in regard to its requirement profile, e. g. lightfastness and weather resistance, mechanical or thermal properties or chemical resistance, do not hesitate to get in touch with us. Your BÜFA team wishes you lots of success!



Gelcoats and Topcoats

Layers just 500-600 µm thick...

... and yet the selection of the right gelcoat is absolutely decisive for the final properties of fibre reinforced as well as cast moulded parts.

That's why quality is so important! Weather fastness, light fastness, degree of gloss, resistance to chemicals and corrosion and, of course, the mechanical properties of a gelcoat surface essentially depend on two factors: First of all, which materials were used to formulate the gelcoat and second, how well the gelcoat is applied in practice.

Optimal for all Applications

We guarantee that our BÜFA®-Gelcoats are made solely from raw materials the behaviour of which has been tested over the long term and which have proved themselves. Users have an extensive line of gelcoats and topcoats in brushing and spraying quality at their disposal.

All gelcoats and topcoats are distinguished by good working properties such as de-airing, flow and wetting of the mould. Optimal thixotropic properties prevent running on vertical surfaces and the reactivity of the base resins used in conjunction with the respective, especially formulated pre-acceleration ensure fast and thorough curing.

Range of Colours

The possibilities for pigmentation are practically unlimited. Along with currently more than 100 standard shades of colour which are always available, practically any nuance can be formulated according to customer wishes. Our entire range includes several thousand, formulated BÜFA® Pigment Pastes for tinting the entire range of gelcoats.

Our proven Eurotinter technology offers the highest degree of flexibility when tinting gelcoats. With this system, which is well-known in the paint and lacquer industry, several thousand pre-formulated shades of colour can be produced.

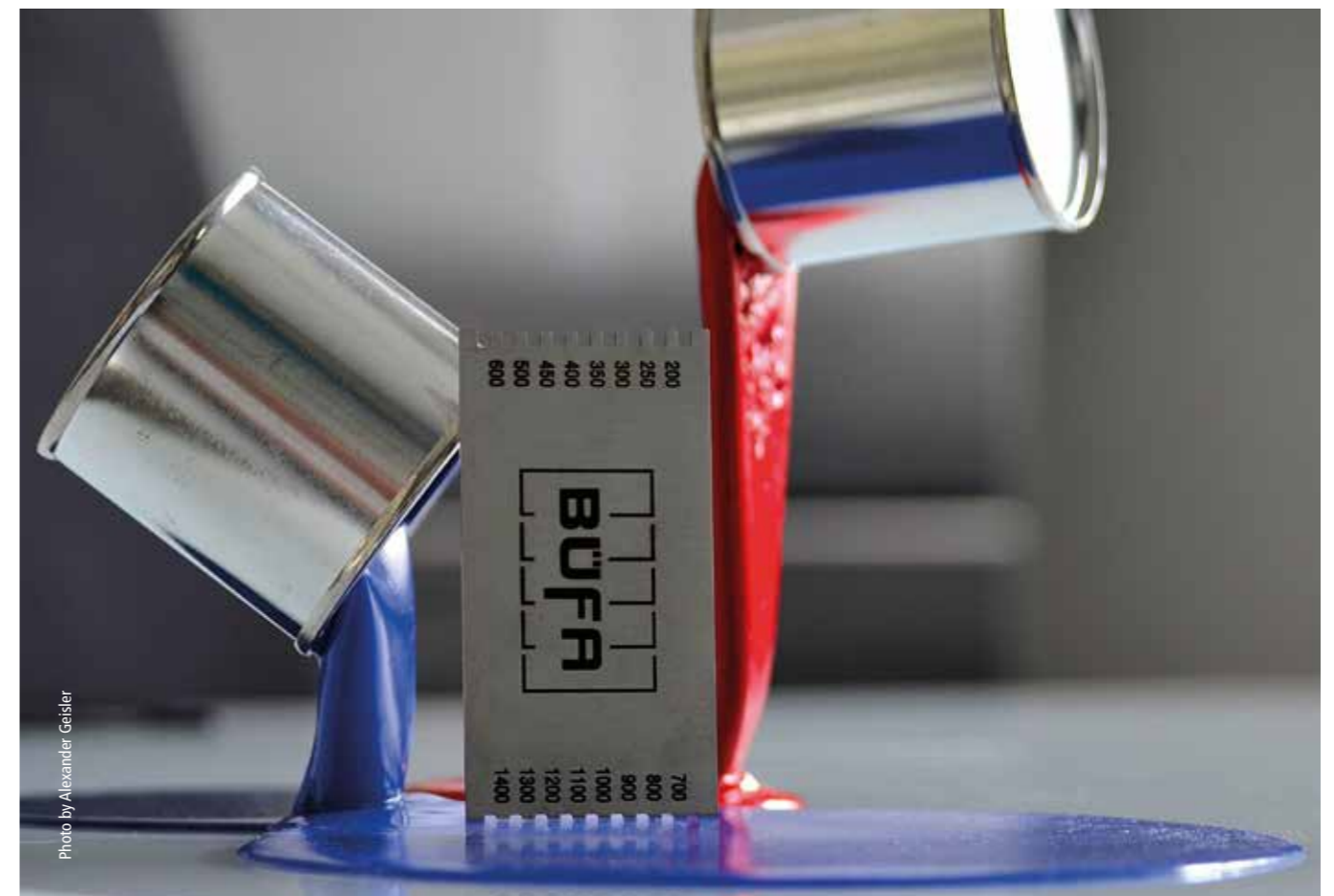

Photo by Alexander Geisler



External Application/ Hydrolysis Loads / Chemical Resistance

Product name	BÜFA®-Marine NPG-Gelcoat-S	BÜFA®-Marine NPG-Gelcoat-H	BÜFA®-Marine NPG-Topcoat-H	BÜFA®-Marine NPG-Spachtel (Filler)	BÜFA®-Gelcoat-S Transparent Clear
Art. No.	748-colour no.	749-colour no.	759-colour no.	737-colour no.	722-2010
Eurotinter	548-colour no.	549-colour no.	559-colour no.	not available	not available
Application	spraying quality	brushing quality	brushing quality	brushing quality	spraying quality
Resin base	IP/NPG	IP/NPG	IP/NPG	IP/NPG	IP/NPG
Pigmentation	practically unlimited	practically unlimited	practically unlimited	limited	transparent
Viscosity [mPa.s] – Spindle/rpm	18,000 – 4/4	23,000 – 4/4	22,000 – 4/4	345,000 – 95/5	14,000 – 4/4
Styrene content [%]	38	34	31	31	40
Peroxide / accelerator	2 % MEKP medium reactive, pre-accelerated	2 % MEKP medium reactive, pre-accelerated	2 % MEKP medium reactive, pre-accelerated	4 % MEKP low reactive, pre-accelerated	2 % MEKP medium reactive, pre-accelerated
Gel time [min]	12	14	14	9	12
Tmax [°C]	165	165	165	165	185
Tensile strength [MPa]	85	85	85	85	85
Tensile E-modulus [MPa]	3,720	3,720	3,720	3,720	3,700
Elongation at break [%]	3.5	3.5	3.5	3.5	4
HDT [°C]	95	95	95	95	94
Range of use / comments	Boat construction, for high chemical, thermal or hydrolytic loads*5, certification GL*1, LR*2	Boat construction, for high chemical, thermal or hydrolytic loads*5, certification GL*1, LR*2	Sealant for high chemical, thermal or hydrolytic loads*5	Filler for sealing and repairing strongly weathered parts with hydrolysis loads	Transparent, weather resistant gelcoat

Product name	NEOGEL®-NPG 8373	NEOGEL®-NPG 8375	NEOGEL®-ECO 9373
Art. No.	610-colour no.	624-colour no.	620-colour no.
Eurotinter	610-colour no.	624-colour no.	620-colour no.
Application	spraying quality	brushing quality	spraying quality
Resin base	IP/NPG	IP/NPG	IP/NPG
Pigmentation	practically unlimited	practically unlimited	limited
Viscosity [mPa.s] – Spindle/rpm	5,800 – 4/20 *3	7,000 – 4/20 *3	39,000 – 4/2 *3
Styrene content [%]	44	37	25
Peroxide / accelerator	2 % MEKP medium reactive, pre-accelerated	2 % MEKP medium reactive, pre-accelerated	2 % MEKP medium reactive, pre-accelerated
Gel time [min]	8 *3	8 *3	9 *3
Tmax [°C]	195 *3	190 *3	170 *3
Tensile strength [MPa]	85	85	83
Tensile E-modulus [MPa]	3,700	3,700	3,500
Elongation at break [%]	4	4	> 3.5
HDT [°C]	94	94	70
Range of use / comments	For high chemical, thermal or hydrolytic loads*5, certification LR*2	For high chemical, thermal or hydrolytic loads*5, certification LR*2	Gelcoat for external components, boat construction, low emission, certification LR*2, best weathering quality in white shades



Highest surface quality that looks like lacquer!

BÜFA®-Ambition-Gelcoat

As Europe's leading supplier of gelcoats, BÜFA Composites continuously invests in the further development of its range of products. One result is the highly brilliant BÜFA®-Ambition-Gelcoat on an isophthalic acid resin base. BÜFA®-Ambition can be used for a number of applications in which surface quality has the highest priority.



Product advantages:

- Production of especially brilliant colours
- Outstanding weathering properties with excellent gloss retention
- For the highest surface quality (looks like lacquer)
- Unique colour accuracy, colour formulations according to customer wishes
- BÜFA®-Ambition is REACH compliant
- Convincing combination of flexibility and good mechanical properties when it comes to tensile and flexural strength



Advantages when processing the product:

- Reliable, uniform quality from batch to batch
- Good stability, optimal flow
- Outstanding hiding power
- No separation of pigments
- Eliminates additional secondary finishing

Processing methods:

- Hand lay-up and spray lay-up
- Available qualities: gelcoats as well as topcoats

Special features:

- Customer-specific colour matching, using especially colour stable pigments
- Weathering test is the basis for releasing the product, test duration approx. 3 months

Production method:

- Batch-wise

Results after weathering according to EN ISO 4892-2:

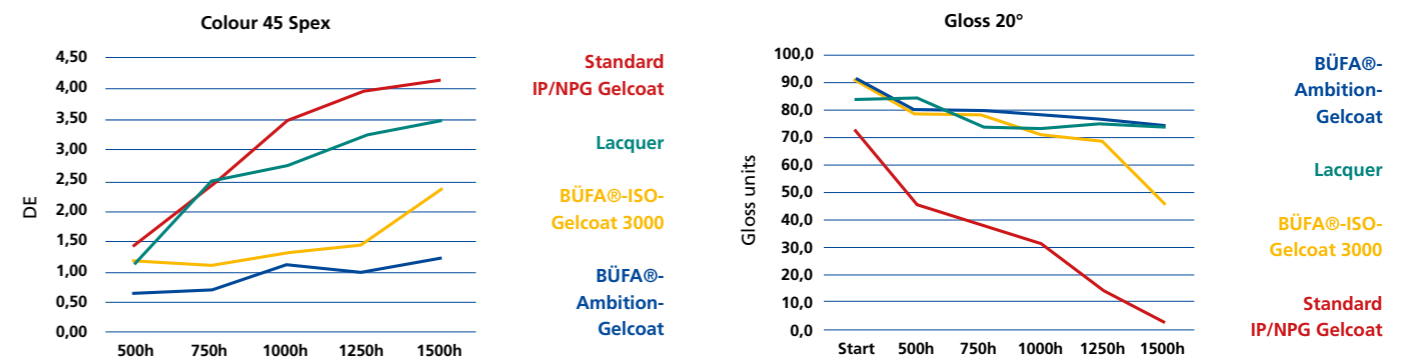

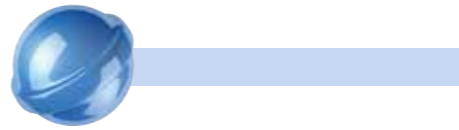

Gelcoat with the best weathering results!



BÜFA®-ISO-Gelcoat 3000

The BÜFA product portfolio includes a number of gelcoats for the most different application areas. BÜFA®-ISO-Gelcoat 3000 can be used for a wide spectrum of applications in which brilliant shades of colour and high UV resistance are required – and that with a good price/performance ratio!



Results of weathering according to EN ISO 4892-2:

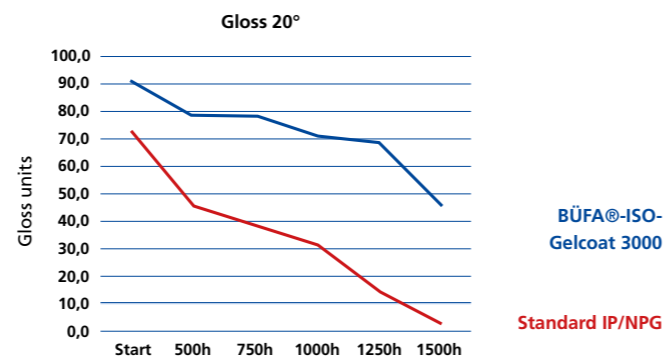
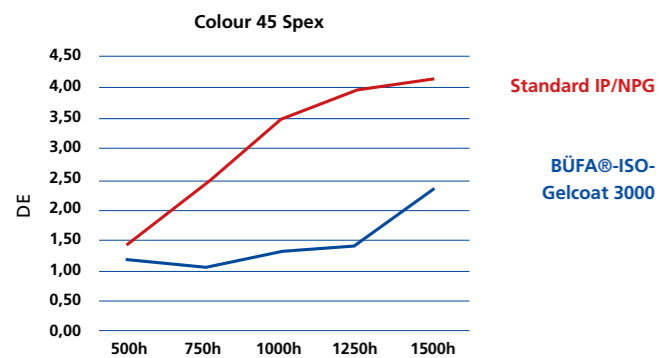

Your product advantages:

- Unique colour accuracy
- With stands strong weathering yet maintains gloss
- BÜFA®-ISO-Gelcoat 3000 is REACH compliant



Advantages in product processing:

- Fast and cost effective processing
- Eliminates additional secondary finishing
- Hand lay-up (BÜFA®-ISO-Gelcoat 3000-H): Due to the higher formulated working viscosity (compared with 3000-S), it can be applied in one working operation
- Spray application (BÜFA®-ISO-Gelcoat 3000-S): Good stability, no separation of pigments

Processing methods:

- Hand lay-up and spray lay-up applications
- Available qualities Gelcoats as well as topcoats

Production method:

- Batchwise / tinting

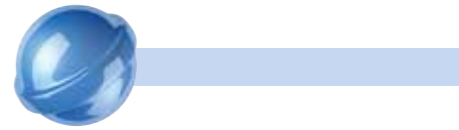

External Application / UV-resistance

Product name	BÜFA®-Ambition-Gelcoat-S	BÜFA®-Ambition-Gelcoat-H	BÜFA®-ISO-Gelcoat-3000-S	BÜFA®-ISO-Gelcoat-3000-H	BÜFA®-Arctic-Gelcoat-ISO-S	BÜFA®-Arctic-Gelcoat-ISO-H
Art. No.	744-colour no.	745-colour no.	771-colour no.	772-colour no.	775-colour no.	776-colour no.
Eurotinter	not available	not available	571-colour no.	572-colour no.	575-colour no.	576-colour no.
Application	spraying quality	brushing quality	spraying quality	brushing quality	spraying quality	brushing quality
Resin base	IP	IP	IP	IP	IP	IP
Pigmentation	practically unlimited	practically unlimited	practically unlimited	practically unlimited	practically unlimited	practically unlimited
Viscosity [mPa.s] – Spindle/rpm	19,000 – 4/4	36,500 – 6/5	20,000 - 4/4	37,500 - 6/5	13,500 – 4/4	17,500 – 4/4
Styrene content [%]	38	31	37	30	34	29
Peroxide / accelerator	2 % MEKP medium reactive, pre-accelerated	2 % MEKP medium reactive, pre-accelerated	2 % MEKP medium reactive, pre-accelerated	2 % MEKP medium reactive, pre-accelerated	1.5 % MEKP medium reactive, pre-accelerated	1.5 % MEKP medium reactive, pre-accelerated
Gel time [min]	10	12	9	12	14	16
Tmax [°C]	190	170	190	170	165	155
Tensile strength [MPa]	85	85	85	85	80	55
Tensile E-modulus [MPa]	3,400	3,400	3,400	3,400	3,900	3,400
Elongation at break [%]	4	4	4	4	3.9	5.3
HDT [°C]	91	91	91	91	90	88
Range of use / comments	Gelcoat with highest weather resistance and gloss retention on varnish level	Highly thixotropic gelcoat with highest weather resistance and gloss retention on varnish level	Gelcoat with very good weather resistance and gloss retention	Highly thixotropic gelcoat with very good weather resistance and gloss retention, WRAS potable water approval 6*	For strong weather or hydrolysis loads, certification GL*1	For strong weather or hydrolysis loads, certification GL*1

Product name	BÜFA®-Arctic-Topcoat-ISO-H	BÜFA®-Arctic-Gelcoat-SP
Art. No.	786-colour no.	756-colour no.
Eurotinter	586-colour no.	556-colour no.
Application	brushing quality	brushing quality
Resin base	IP	IP
Pigmentation	practically unlimited	practically unlimited
Viscosity [mPa.s] – Spindle/rpm	17,500 – 4/4	425,000 – 95/5
Styrene content [%]	29	29
Peroxide / accelerator	1.5 % MEKP medium reactive, pre-accelerated	1.5 % MEKP medium reactive, pre-accelerated
Gel time [min]	14	16
Tmax [°C]	165	155
Tensile strength [MPa]	55	55
Tensile E-modulus [MPa]	3,400	3,400
Elongation at break [%]	5.3	3.9
HDT [°C]	88	88
Range of use / comments	Sealant for components subjected to strong weather and hydrolysis loads	Filler for sealing and repairing components with strong weather and hydrolysis loads



Copyright: Kässbohrer Geländefahrzeug AG



BÜFA®-Standard Gelcoats and -Topcoats

With this line of products, BÜFA Composite Systems sets new standards in the area of "performance gelcoats" for the GRP industry. An isophthalic acid modified, low-styrene resin formulation is the basis for all BÜFA®-Standard Gelcoats and Topcoats.

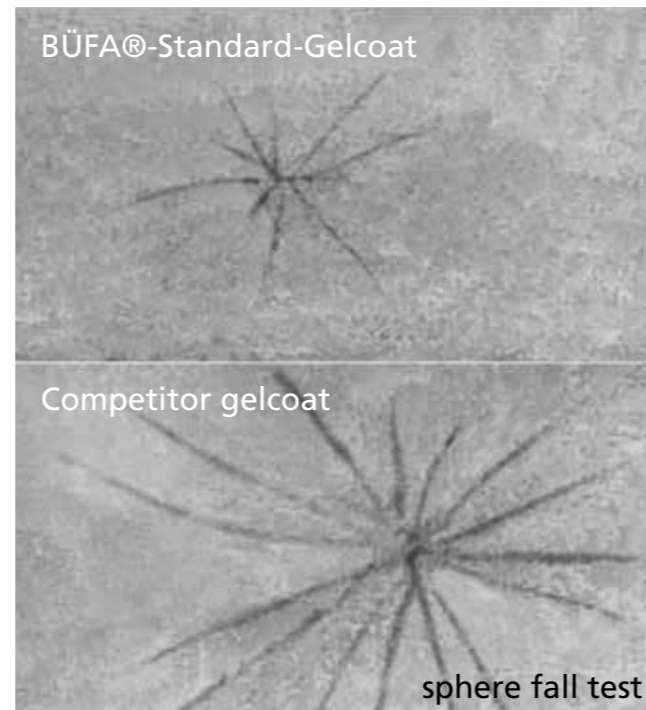

Advantages of BÜFA®-Standard Gelcoats and Topcoats

- This line of products convinces through significantly low emission of styrene and because of its good working properties. Gelcoat surfaces produced with BÜFA®-Standard Gelcoat are also convincing in their product class because of their excellent weathering stability.
- A flexibilised formulation of the material guarantees high impact resistance which results in less tendency of the gelcoat surfaces to crack, particularly in the case of large components (e.g. machine housing for wind power plants).
- For sealing the back sides of laminates, pre-accelerated BÜFA®-Standard Topcoats in the same colour and quality are available. All of the topcoats are formulated with special paraffin to ensure tack-free curing at working temperatures up to max. 35 °C.
- BÜFA®-Standard Gelcoats and Topcoats are available ready to use in the colours light grey (RAL 7035), pure white (RAL 9010) and agate grey (RAL 7038).
- A ready to use base formulation that can be individually tinted through tinting technology is also available.

What distinguishes the BÜFA®-Standard Gelcoat line of products?

- Saves time, materials and working steps
- Pre-accelerated
- GL approvals
- Good weathering properties
- Low emission of styrene
- Excellent mechanical properties

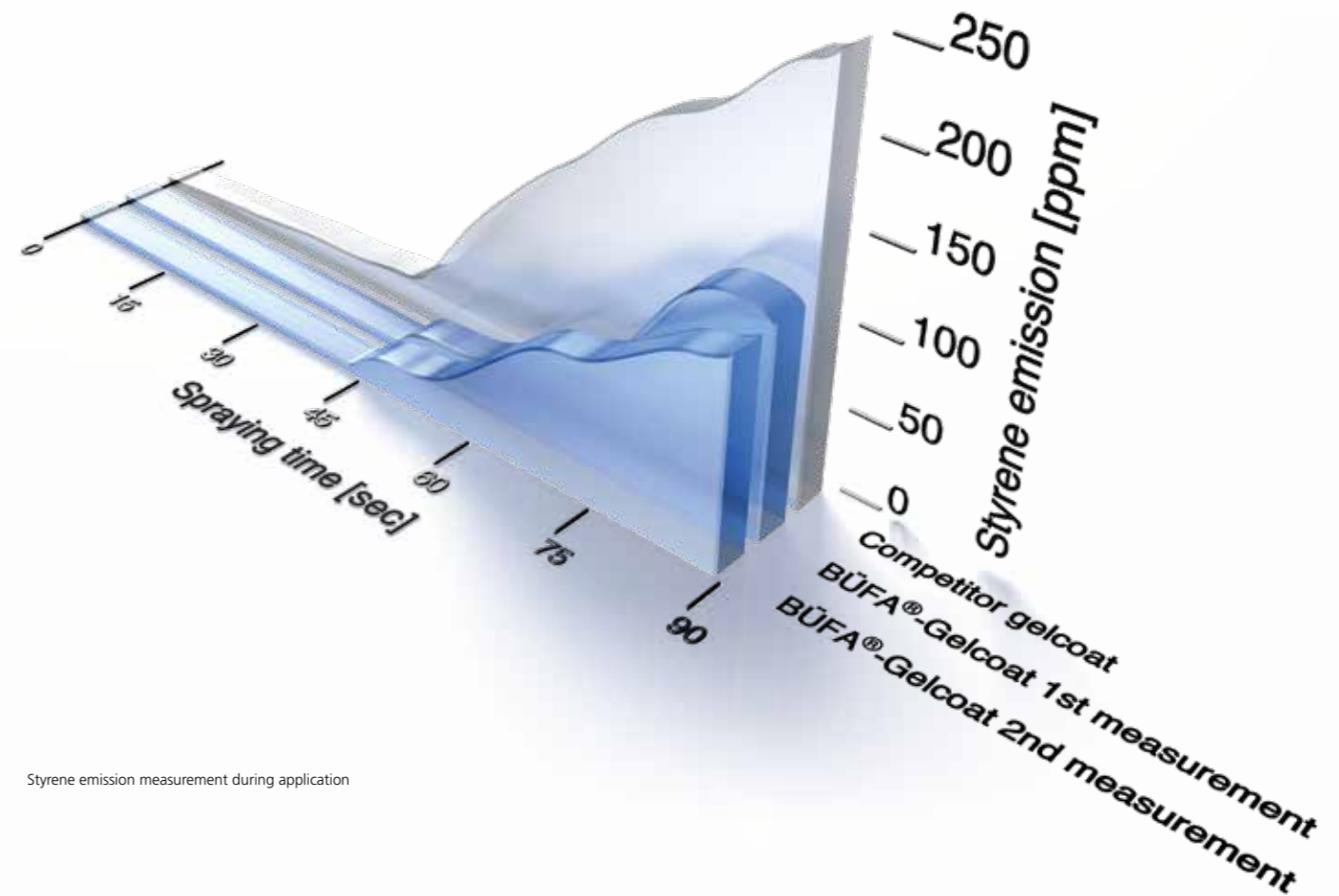

Styrene emission measurement during application

Standard Application

Product name	BÜFA®-Standard-Gelcoat-S	BÜFA®-Standard-Gelcoat-H	BÜFA®-Standard-Topcoat-S	BÜFA®-Standard-Topcoat-H	BÜFA®-Standard-Gelcoat-H
Article group	764-colour no.	765-colour no.	766-colour no.	767-colour no.	768-colour no.
Eurotinter	564-colour no.	565-colour no.	566-colour no.	567-colour no.	568-colour no.
Application	spraying quality	brushing quality	spraying quality	brushing quality	brushing quality
Base resin	OP/IP	OP/IP	OP/IP	OP/IP	OP/IP
Pigmentation	nearly unlimited	nearly unlimited	nearly unlimited	nearly unlimited	nearly unlimited
Viscosity [mPa.s] – Spindle/rpm	16,000 – 4/4	34,000 – 4/4	13,500 – 4/4	34,000 – 4/4	51,000 – 6/5
Styrene content [%]	30	28	29	27	28
Peroxide / accelerator	2 % MEKP medium reactive, pre-accelerated	2 % MEKP medium reactive, pre-accelerated	2 % MEKP medium reactive, pre-accelerated	2 % MEKP medium reactive, pre-accelerated	2 % MEKP medium reactive, pre-accelerated
Gel time [min]	11	17	11	17	9
Tmax [°C]	165	155	165	155	165
Tensile strength [MPa]	48	48	48	48	48
Tensile E-modulus [MPa]	3,000	3,000	3,000	3,000	3,000
Elongation at break [%]	6.5	6.5	6.5	6.5	6.5
HDT [°C]	80	80	80	80	80
Range of use / comments	Gelcoat for machine parts and technical components, low-styrene, certification GL *1	Gelcoat for machine parts and technical components, low-styrene, certification GL *1	Sealant for technical components that are not subjected to permanent water loads, certification GL *1	Sealant for technical components that are not subjected to permanent water loads, certification GL *1	Gelcoat for machine parts and technical components, low-styrene, certification GL *1



Industry- and Special Application

Product name	BÜFA®-Sanitary-Gelcoat-S	BÜFA®-Sanding-Gelcoat-S light grey	BÜFA®-Industry-Gelcoat-2.0-S
Art. No.	712-XXXX	722-7335	669-colour no.
Application	spraying quality	spraying quality	spraying quality
Resin base	IP/NPG	IP	OP
Pigmentation	various white shades	light grey	limited
Viscosity [mPa.s] – Spindle/rpm	17,000 – 5/5	17,000 – 5/5	18,000 – 4/4
Styrene content [%]	34	21	31
Peroxide / accelerator	2 % MEKP medium reactive, pre-accelerated	2 % MEKP medium reactive, pre-accelerated	2 % MEKP medium reactive, pre-accelerated
Gel time [min]	9	21	10
Tmax [°C]	170	110	170
Tensile strength [MPa]	75	90	78
Tensile-E-modulus [MPa]	3,800	3,700	4,300
Elongation at break [%]	3,4	4,6	5
HDT [°C]	90	90	98
Range of use / comments	Sanitary gelcoat with increased scratch resistance	Gelcoat for moulded parts that can be varnished, easily sanded	Gelcoat for technical and industrial components

Product name	BÜFA®-VE-Gelcoat	BÜFA®-Conductive-Gelcoat black	BÜFA®-VEU-Conductive-Gelcoat black
Art. No.	724-colour no.	722-0399	722-0262
Application	brushing quality	brushing quality	brushing quality
Resin base	BPA/VE	IP/BPA/VEU	BPA/VEU
Pigmentation	limited	black	black
Viscosity [mPa.s] – Spindle/rpm	25,000 – 5/5	13,500 – 6/20	13,500 – 6/20
Styrene content [%]	37	34	34
Peroxide / accelerator	2 % CuHP/Promotor + 2 % 742-0062, not pre-accelerated	2 % MEKP medium reactive, pre-accelerated	2 % MEKP low reactive, pre-accelerated
Gel time [min]	13	22	16
Tmax [°C]	155	116	160
Tensile strength [MPa]	95	not determined	90
Tensile-E-modulus [MPa]	3,600	not determined	3,500
Elongation at break [%]	6.1	approx. 10	3 - 4
HDT [°C]	105	approx. 90	145
Range of use / comments	Vinyl ester gelcoat for extreme chemical loads*5, not weather resistant	Gelcoat for moulded parts that not only require electrical conductivity but also basic fire protection	Gelcoat for moulded parts that not only require electrical conductivity but also chemical resistance*5



Tooling Gelcoats

Product name	BÜFA®-Conductive-Tooling GC-S natur	BÜFA®-VE-Tooling-Gelcoat-S nature	BÜFA®-VE-Tooling-Gelcoat-H nature
Art. No.	720-0100 (nature)	720-1000	720-2000
Application	spraying quality	spraying quality	brushing quality
Resin base	Hybrid	BPA/VEU	BPA/VEU
Pigmentation	520-0101 (black) / 520-0102 (green)	nature	nature
Viscosity [mPa.s] – Spindle/rpm	24,000 - 4/4	33,000 -4/2	53,000 -4/2
Styrene content [%]	49	40	40
Peroxide / accelerator	2 % MEKP moderately reactive, pre-accelerated	2 % MEKP moderately reactive, pre-accelerated	2 % MEKP moderately reactive, pre-accelerated
Gel time [min]	15	14	14
Tmax [°C]	195	185	185
Elongation at break [%]	> 3	> 3	> 3
HDT [°C]	120	130	110
Range of use / comments	Conductive properties [10 ⁶ Ω], thixotropic mould making gelcoat, good gloss performance,	GRP mould-making, available in 4 shades of colour and a non-tinted version, not weather resistant	GRP mould-making, available in 4 shades of colour and a non-tinted version, not weather resistant



To achieve the greatest contrast to the moulded part, black is the optimal colour for white products. Green is the optimal colour for white products with dark blue stripes. Orange is the commonly used colour for light blue products. Grey is the last colour to complete the series of tooling gelcoats.

Available Gelcoat Colours



Colour	Art. No. spraying quality	Art. No. brushing quality
Black	520-1104	520-2107
Light Green	520-1108	520-2109
Orange	520-1110	520-2111
Grey	520-1112	520-2113
Nature	720-1000	720-2000



BÜFA®-Barriercoat – Enhanced surface quality

Take advantage of the improved surface quality achieved with BÜFA®-Barriercoat

BÜFA®-Barriercoat is applied between the gelcoat and the laminate build up.

As a kind of additional Gelcoat layer, BÜFA®-Barriercoat improves surface cosmetics and resistance against osmosis. BÜFA®-Barriercoat is based on a vinyl ester resin. Due to its excellent mechanical properties and low shrink curing behaviour, it will help to avoid fibre print through on composite material surfaces. Due to its low water absorption, special composition and excellent chemical resistance, the osmosis resistance of a laminate with BÜFA®-Barriercoat will improve substantially.

Depending on build-up and chemical exposure, first layer of laminates behind the gelcoat can potentially be replaced. BÜFA®-Barriercoat may be used in applications such as swimming pools, automotive parts and GRP toolings.

BÜFA®-Barriercoat is available in a range of different colours.

Benefits for you at a glance:

- Protection against osmosis
- Substantial improvement of the surface quality
- Can be used in spray lay-up as well as in hand lay-up processes
- Excellent price performance ratio
- Low styrene content
- Time saving by replacing the first layer of resin
- 722-1965 GL approval

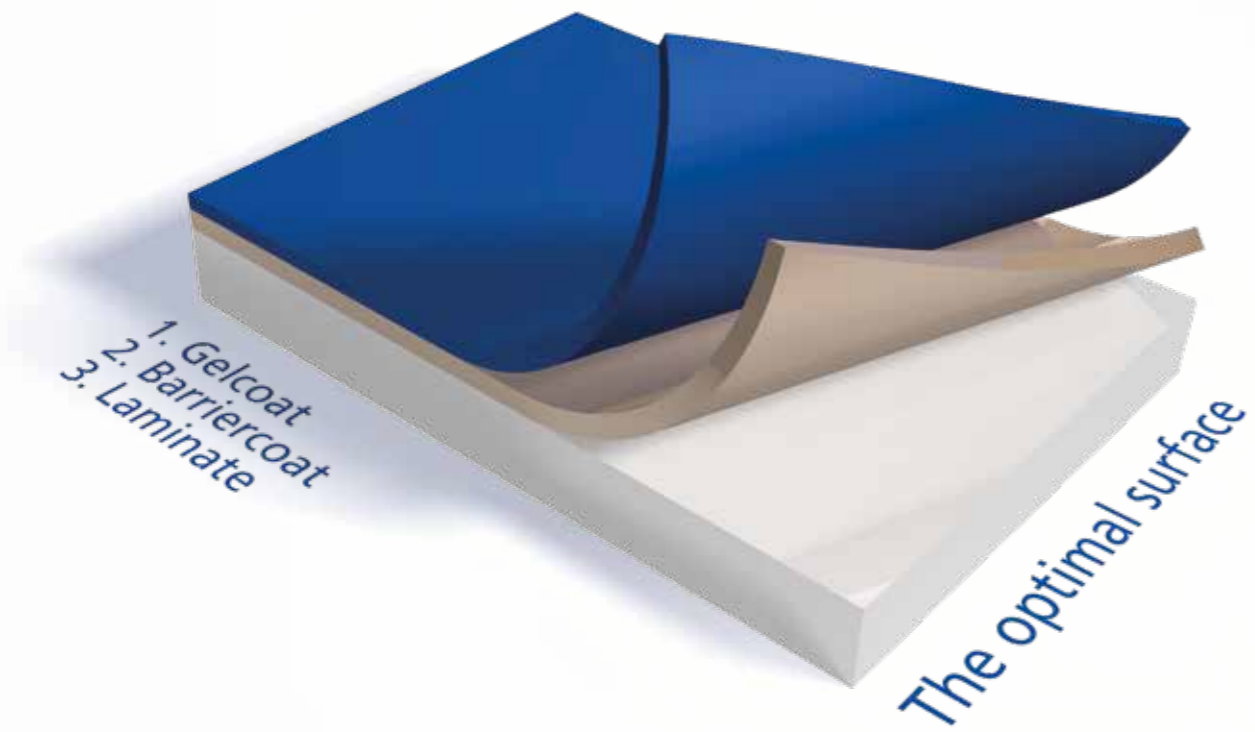

BÜFA®-Barriercoat is available in different colours:

Art. No.	Product name	Colour	Application
722-1965	BÜFA®-VE Barriercoat SV 2 (flex)	Beige	spraying quality
722-1966	BÜFA®-VE Barriercoat SV	Beige	spraying quality
722-1967	BÜFA®-VE Barriercoat SV Yellow	Yellow	spraying quality
722-1968	BÜFA®-VE Barriercoat SV Blue	Blue	spraying quality



Fire Protection Gelcoats

Gelcoat name	BÜFA®-Firestop GC S 230	BÜFA®-Firestop GC S 250	BÜFA®-Firestop GC S 260	BÜFA®-Firestop GC S 270	BÜFA®-Firestop GC S 285	BÜFA®-Firestop GC S 300
Art. No	714-2300	708-colour (spraying quality) / 728-colour (brushing quality)	714-2600	714-2702	714-2852	714-3000
Resin base	IP	IP	OP / NPG	VE / DCPD	IP	VE / DCPD
Non-volatile matter [%]	82	Colour 708 = 77 Colour 728 = 84	76	84	80	85
Viscosity [mPa.s]	30,000	Colour 708 = 7,500 Colour 728 = 30,000	11,500	28,000	14,000	25,000
Elongation at break [%]	5	8.2	3.4	3	4.5	2.5
Tensile strength [MPa]	50	52	56	45	48	45
HDT [°C]	59	41	39	60	36	85
Comments	Gelcoat in a spraying quality with increased fire protection properties	Gelcoat in a spraying quality with good fire protection properties	Gelcoat in a spraying quality with increased fire protection properties	Gelcoat in a hand and spraying quality with highest fire protection properties	Gelcoat in a hand and spraying quality with highest fire protection properties	Gelcoat in a spraying quality with highest fire protection properties

Chemical properties	DCPD: dicyclopentadiene	OP: orthophthalic acid	IP: isophthalic acid	VE: vinyl ester	NPG: neopentyl glycol
---------------------	-------------------------	------------------------	----------------------	-----------------	-----------------------

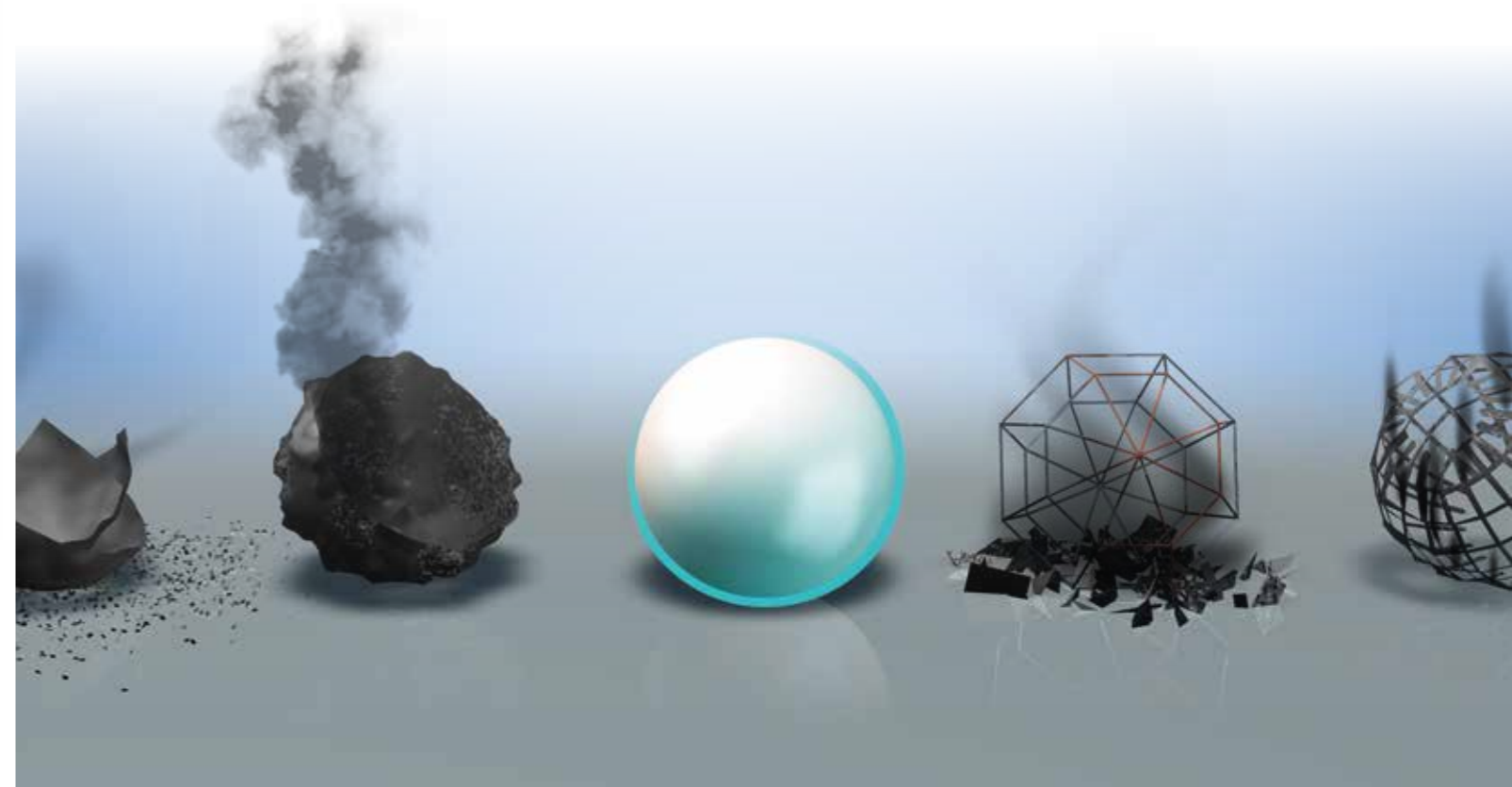

Gelcoats and Topcoats

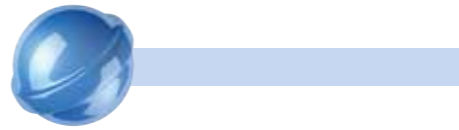

BÜFA®-Swim-NPG Gelcoats and Topcoats

Swimming pools are eye-catchers and enhance the quality of life. After they have been applied, the BÜFA®-Swim-NPG Gelcoats and Topcoats give pools a high quality surface.

What distinguishes the BÜFA®-Swim-NPG series?

- Based on ISO/NPG quality
- Excellent resistance to hydrolysis
- Highly UV and weather resistant
- Individual colours, tested and released according to the AVK chlorine test method
- A special laminate construction combined with BÜFA®-Swim-NPG Gelcoat allows permanent utilisation at elevated water temperatures

A variety of colours

	Blue 0823		Papyrus white 9797
	Pool blue 5494		White 9400
	Lime green 6349		Beige 1309
	Light blue 5516		Blue 5484



Gelcoats and Topcoats



Swimming Pool Applications

Product name	BÜFA®-Swim-NPG-Gelcoat-S	BÜFA®-Swim-NPG-Gelcoat-H	BÜFA®-Swim-NPG-Topcoat-S	BÜFA®-Swim-NPG-Topcoat-H
Art. No.	752-colour no.	753-colour no.	762-colour no.	763-colour no.
Application	spraying quality	brushing quality	spraying quality	brushing quality
Resin base	IP/NPG	IP/NPG	IP/NPG	IP/NPG
Pigmentation	limited	limited	limited	limited
Viscosity [mPa.s] – Spindle/rpm	18,000 – 4/4	29,000 – 5/5	18,000 – 4/4	20,000 – 5/5
Styrene content [%]	38	31	38	31
Peroxide / accelerator	2 % MEKP medium reactive, pre-accelerated	2 % MEKP medium reactive, pre-accelerated	2 % MEKP medium reactive, pre-accelerated	2 % MEKP medium reactive, pre-accelerated
Gel time [min]	12	14	14	9
Tmax [°C]	165	165	165	165
Tensile strength [MPa]	85	85	85	85
Tensile E-modulus [MPa]	3,720	3,720	3,720	3,720
Elongation at break [%]	3.5	3.5	3.5	3.5
HDT [°C]	95	95	95	95
Range of use / comments	Gelcoat for swimming pools, colours especially tested according to the AVK chlorine test *4	Gelcoat for swimming pools, colours especially tested according to the AVK chlorine test *4	Topcoat for swimming pools, colours especially tested according to the AVK chlorine test *4	Topcoat for swimming pools, colours especially tested according to the AVK chlorine test *4

The legend refers to the values of the category of Gelcoats and Topcoats

Resin base	Comments	Reactivity	Viscosity	Accelerator	Mechanical values
IP - isophthalic acid	*1 Approval according to GL (Germanischer Lloyd)	Reactivity values are orientation values measured on a 100 g sample at 20 °C or 25 °C (*4)	Mean values measured with Brookfield DV II at 20 °C or 25 °C *3	742-0399 BÜFA®-Accelerator Complex 0399	Measured on cured, pure resin samples made of the base resin conditioned according to information in the Technical Information Sheet
OP - orthophthalic acid	*2 Approval according to Lloyd's Register				
VE - vinyl ester		Gel time: Time from 20 °C to 30 °C (mean value) or from 25 °C to 35 °C (mean value) *4	Further values: e.g. measured with spindle 4 at 4 rpm (4/4)	742-0062 BÜFA®-Accelerator Co 1	Tensile strength according to ISO 527/2
DCPD - dicyclopentadiene	*3 Measured at 25 °C				
BPA - bisphenol A	*4 Industrievereinigung Verstärkte Kunststoffe e. V., Enclosure 2 of the Manufacturing Guideline on GRP Swimming Pools, section 6.1	Tmax: Maximum temperature of the 100 g sample (mean value)			Tensile E-modulus according to ISO 527/2
VEU - vinyl ester urethane					Elongation at break according to ISO 527/2
NPG - neopentylglycol	*5 For use with chemical loads, please contact our Technical Service Department				HDT according to ISO 75-A
	*6 Approval according to WRAS (Water Regulations Adisory Scheme)				

The Gelcoat Applications at a glance



The recommendations presented are only a few of the possibilities for gelcoat applications. For further information, get in touch with our Technical Service.

Gelcoat	Art. No.	Product name	Description	Resin base	Application	Viscosity [mPas] - Spindle/rpm	Gel time [min]	Marine		Swimming pools	Auto-motive	Sanitary	Mould making	Wind energy		Travel trailers/ Caravans	Transport utility vehicles		Chemical resistance
								Exterior	Interior					Rotorblades	Casing		varnished	unvarnished	
Industry	669-XXXX	BÜFA®-Industry-Gelcoat 2.0	Gelcoat for technical and technical components	OP	spraying quality	18,000 - 4/4	10												
Standard	764-XXXX	BÜFA®-Standard-Gelcoat-S	Machine parts, industrial moulded parts, low-styrene, approved by GL *1	OP/IP	spraying quality	16,000 - 4/4	11		✓						✓		✓		
	765-XXXX	BÜFA®-Standard-Gelcoat-H	Machine parts, industrial moulded parts, low-styrene, approved by GL *1	OP/IP	brushing quality	34,000 - 4/4	17		✓						✓		✓		
	766-XXXX	BÜFA®-Standard-Topcoat-S	Sealant for industrial moulded parts that are not permanently subjected to water loads, approved by GL *1	OP/IP	spraying quality	13,500 - 4/4	11		✓	✓	✓				✓	✓		✓	
	767-XXXX	BÜFA®-Standard-Topcoat-H	Sealant for industrial moulded parts that are not permanently subjected to water loads, approved by GL *1	OP/IP	brushing quality	34,000 - 4/4	17		✓	✓	✓				✓	✓		✓	
	768-XXXX	BÜFA®-Standard-Gelcoat-H	Machine parts, industrial moulded parts, low-styrene, high thixotropy	OP/IP	brushing quality	51,000 - 6/5	9		✓						✓			✓	
Exterior application	744-XXXX	BÜFA®-Ambition-Gelcoat-S	Gelcoat with highest weather resistance and gloss retention, on varnish level	IP	spraying quality	13,500 - 4/4	14		✓		✓					✓		✓	
	745-XXXX	BÜFA®-Ambition-Gelcoat-H	Highly thixotropic gelcoat with highest weather resistance and gloss retention, on varnish level	IP	brushing quality	17,500 - 4/4	16		✓		✓					✓		✓	
	771-XXXX	BÜFA®-ISO-Gelcoat-3000-S	Gelcoat with very good weather resistance and gloss retention.	IP	spraying quality	20,000 - 4/4	9		✓		✓				✓	✓		✓	
	772-XXXX	BÜFA®-ISO-Gelcoat-3000-H	Highly thixotropic gelcoat with very good weather resistance and gloss retention, WRAS potable water approval, 6*	IP	brushing quality	37,500 - 6/5	12		✓		✓				✓	✓		✓	
	775-XXXX	BÜFA®-Arctic-Gelcoat-ISO-S	For strong weathering or hydrolytic loads, fulfills approved by GL *1	IP	spraying quality	13,500 - 4/4	14	✓	✓		(✓)				✓	✓		✓	
	776-XXXX	BÜFA®-Arctic-Gelcoat-ISO-H	For strong weathering or hydrolytic loads, fulfills approved by GL *1	IP	brushing quality	17,500 - 4/4	16	✓	✓		(✓)				✓	✓		✓	
	786-XXXX	BÜFA®-Arctic-Topcoat-ISO-H	For sealing parts subjected to strong weathering and hydrolytic loads	IP	brushing quality	17,500 - 4/4	14	✓	✓		(✓)				✓	✓		✓	
	756-XXXX	BÜFA®-Arctic-Gelcoat-SP	Gelcoat filler for sealing and repairing parts subjected to strong weathering and hydrolytic loads	IP	brushing quality	425,500 - 95/5	16	✓	✓		(✓)				✓	✓		✓	
Exterior application / hydrolysis loads / chemical resistance	748-XXXX	BÜFA®-Marine-NPG-Gelcoat-S	Boat construction, for high hydrolytic loads, approved by GL, LR *1, *2	IP/NPG	spraying quality	18,000 - 4/4	12	✓	✓			✓							(✓)
	749-XXXX	BÜFA®-Marine-NPG-Gelcoat-H	Boat construction, for high hydrolytic loads, approved by GL, LR *1, *2	IP/NPG	brushing quality	23,000 - 4/4	14	✓	✓			✓							(✓)
	759-XXXX	BÜFA®-Marine-NPG-Topcoat-H	For sealing parts subjected to strong weathering and hydrolytic loads	IP/NPG	brushing quality	22,000 - 4/4	14	✓	✓										(✓)
	737-XXXX	BÜFA®-Marine-NPG Spachtel	Filler for sealing and repairing parts that are strongly weathered or have been subjected to hydrolysis loads	IP/NPG	brushing quality	345,000 - 95/5	12	✓	✓			✓							
	610-XXXX	NEOGEL®-NPG 8373	Boat construction, for high hydrolytic loads, approved by LR *2	IP/NPG	spraying quality	5,800*3- 4/20	8	✓	✓	(✓)		✓							(✓)
	624-XXXX	NEOGEL®-NPG 8375	Boat construction, for high hydrolytic loads, approved by LR *2	IP/NPG	brushing quality	7,000*3- 4/20	8*3	✓	✓	(✓)		✓							(✓)
	722-2010	BÜFA®-Gelcoat-S Transparent Clear	Transparent and weather resistant gelcoat	IP/NPG	spraying quality	14,000 - 4/4	12		(✓)		✓	✓				✓			
	620-XXXX	NEOGEL®-Eco 9373 W-2	Gelcoat for sanitary/boat construction/exterior parts, low-emission, best weathering quality in white shades	IP/NPG	spraying quality	39,000*3- 4/2	9	✓	✓			✓				✓			
Swimming Pools	752-XXXX	BÜFA®-Swim-NPG-Gelcoat-S	Gelcoat for swimming pools, colours specially tested according to the AVK chlorine test *4	IP/NPG	spraying quality	18,000 - 4/4	12	✓		✓									
	753-XXXX	BÜFA®-Swim-NPG-Gelcoat-H	Gelcoat for swimming pools, colours specially tested according to the AVK chlorine test *4	IP/NPG	brushing quality	29,000 - 5/5	14	✓		✓									
	762-XXXX	BÜFA®-Swim-NPG-Topcoat-S	Topcoat for swimming pools, colours specially tested according to the AVK chlorine test *4	IP/NPG	spraying quality	18,000 - 4/4	14	✓		✓									
	763-XXXX	BÜFA®-Swim-NPG-Topcoat-H	Topcoat for swimming pools, colours specially tested according to the AVK chlorine test *4	IP/NPG	brushing quality	20,000 - 5/5	9	✓		✓									
Mould making	720-0100	BÜFA®-Conductive-Tooling GC-S nature	Thixotropic mould making gelcoat with conductive properties [10 ⁶ Ω], good gloss performance	Hybrid	spraying quality	24,000 - 4/4	15						✓						
	720-1000	BÜFA®-VE-Tooling-Gelcoat-S	Gelcoat for GRP tooling, available in black, green, orange, grey	BPA/VEU	spraying quality	33,000 - 4/2	14						✓						
	720-2000	BÜFA®-VE-Tooling-Gelcoat-H	Gelcoat for GRP tooling, available in black, green, orange, grey	BPA/VEU	brushing quality	53,000 - 4/2	14						✓						
Special	724-XXXX	BÜFA®-VE-Gelcoat	Vinyl ester gelcoat for extreme chemical loads, not resistant to weather, not pre-accelerated	VE	brushing quality	25,000 - 5/5	13												(✓)
	722-1965	BÜFA®-VE-Barriercoat-SV 2	Second layer of gelcoat between the gelcoat and laminate as a barrier against shrinkage marks and osmosis / certification GL 1*	VE	spraying quality	25,000 - 4/2	25	✓	✓	✓	✓		✓			✓	✓	✓	
	722-1966	BÜFA®-VE-Barriercoat-SV	Second layer of gelcoat between the gelcoat and laminate as a barrier against shrinkage marks and osmosis	VE	spraying quality	24,500 - 4/3	13	✓	✓	✓	✓		✓			✓	✓	✓	
	722-0399	BÜFA®-Conductive Gelcoat black	Gelcoat for moulded parts that require not only electrical conductivity but also basic fire protection	IP/BPA/VEU	brushing quality	13,500 - 6/20	22												(✓)
	722-0262	BÜFA®-VEU Conductive Gelcoat black	Gelcoat for moulded parts that not only require electrical conductivity but also chemical resistance *5	BPA/VEU	brushing quality	13,500 - 6/20	16												
	712-XXXX	BÜFA®-Sandling Gelcoat S light grey	Gelcoat for paintable moulded parts	IP	spraying quality	17,500 - 5/5	21				(✓)							✓	
	722-7355	BÜFA®-Sanitary Gelcoat S	Sanitary Gelcoat with increased scratch resistance	IP/NPG	spraying quality	17,500 - 5/5	9						✓						

Abbreviations for base resins: IP - Isophthalic acid, OP - Orthophthalic acid, VE-Vinylester, NPG - Neopentylglycol, BPA/VEU - Bisphenol A Vinylester Urethan
 Notes: *1 - GL approval (Germanischer Lloyd)
 *2 - Lloyd's approval (Lloyd's register)
 *3 - measured at 25 °C
 *4 - Industrievereinigung Verstärkte Kunststoffe e. V., Enclosure 2 of the Manufacturing Guideline on GRP Swimming Pools, section 6.1
 *5 - For use with chemical loads, please contact our Technical Service Department
 *6 - WRAS approval (Water Regulations Adisory Scheme)

Viscosity: Mean values measured with Brookfield DV II at 20 °C, *3 Mean values measured with Brookfield DV II at 25 °C
 Further specifications: e. g. measured with spindle 4 at 4 rpm (4/4)
 The gel time stated was determined based on the information given in the Technical Data Sheets.
 (✓) conditionally suitable
 ✓ suitable
 XXXX Serial colour number

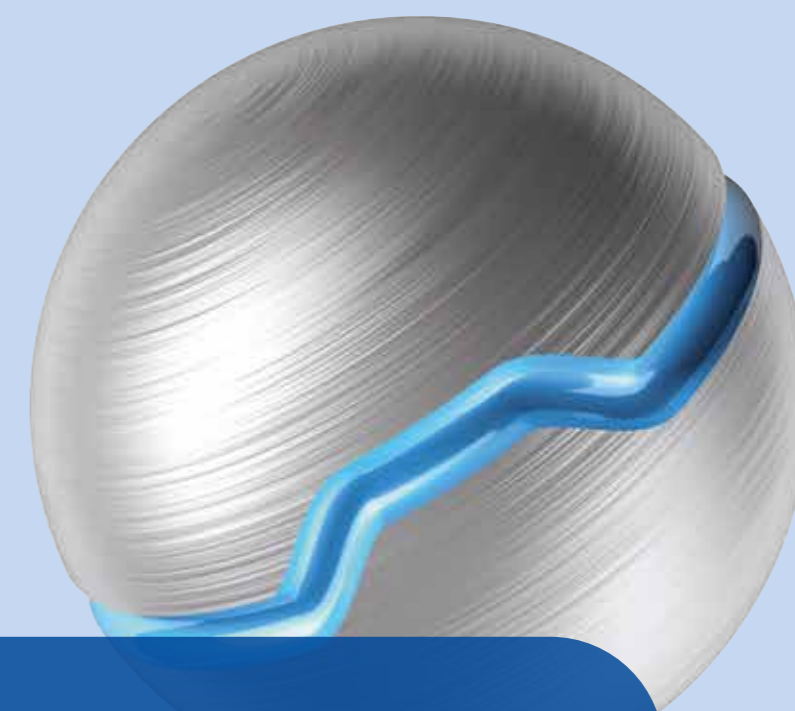

POWERFUL CONNECTIONS

Bonding Pastes, Fillers & High Performance Adhesives

Composites

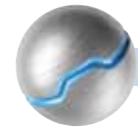

Copyright: Astilleros Astondoa S.A.

Bonding Pastes, Fillers and High Performance Adhesives

Quality...

... is what the extensive line of BÜFA®-Bonding Pastes is about. Here you will find the right adhesive/bonding paste for your individual requirements at a glance.

Filled or unfilled products, with or without fibre reinforcement, with low specific gravity for bonding sandwich constructions, low-shrink formulated, elastic or tinted bonding pastes and many other variations are available to our customers.

Oriented to the six categories listed you will quickly find the right bonding paste for your application. You don't have the right product for your purpose? No problem!

Just give us a call and together we will find a solution. It's very important for us to be up to date on the latest requirements.

Proved, innovative and tailor-made products – we provide what you need.

“Are you bonding already or still using screws?”

ITW PLEXUS – High performance adhesives

ITW PLEXUS stands for high quality construction adhesives. A combination of easy handling and outstanding adhesive strength guarantee that PLEXUS adhesives are the solution for a wide range of applications.

PLEXUS construction adhesives have excellent adhesive properties for composite materials, engineering plastics and metals and reduce the need to use conventional, mechanical fastenings.

PLEXUS adhesives can be used in many branches e.g.:

- Boat construction
- Transport sector
- Automotive industry and
- Building industry

From a cartridge (50-400 ml) for smaller applications all the way to bulk use (20-200 l) for larger projects.

Our recommendations for you:

Working parameters

- Use at least 1.5 % MEKP
- Working temperature between 18-24 °C
- The surface should be clean and free of grease and dust
- Low resin surface in bonding area
- Sand the substrate before bonding
- Prime wood and metals

Your advantages

- High-strength bonding of different materials
- High fatigue strength, impact resistance and elongation at break
- Promotes processing (levelling, round edges)
- Optimal surface quality through low-shrink systems
- Reduction of weight, vibrations and noise



Copyright: VDL Bus & Coach

Bonding Pastes and Fillers, High Performance Adhesives

Product name	BÜFA®-Bonding Paste 0110	BÜFA®-Bonding Paste 0111	BÜFA®-Bonding Paste 0114	BÜFA®-Bond 001	BÜFA®-Bonding Paste 0185	BÜFA®-Bonding Paste 0250	BÜFA®-Bonding Paste 0588	BÜFA®-Bonding Paste 0591
Art. No.	740-0110	740-0111	740-0114	660-0001	740-0185	740-0250	740-0588	740-0591
Category	High strength bondings	High strength bondings	High strength bondings	Structural bondings	Structural bondings	Structural bondings	Structural bondings	Structural bondings
Resin base	BPA/VE	BPA/VE	BPA/VE	/	THP	OP	THP	IP
Colour	opaque / natural	opaque / natural	opaque / natural	green	green	blue	grey	grey
Peroxide indicator	no	no	no	ja	no	no	no	no
Viscosity [mPa.s]	1,800,000	1,800,000	1,800,000	580,000	550,000	950,000	600,000	500,000
Brookfield 20 °C (U/Min)	96 / 3	96 / 3	96 / 3		7 / 5	95 / 5	7 / 5	7 / 5
Pre-accelerated	Co	Co	Co	BPO / Amine (pre-assembled)	Co	Co	Co	Co
Peroxide	2,5 % by weight medium reactive MEKP	2,5 % by weight medium reactive MEKP	2,5 Vol% medium reactive MEKP	forced mixing resin / hardener = 10 to 1	2 % by vol. higher reactivity MEKP	2 % by vol. medium reactive MEKP	2 % by vol. medium reactive MEKP	2 % by vol. medium reactive MEKP
Gel time [min]	at	60 at 25 °C	35	10	27	20	10	13
Curing time [min]			60	14	37	35	17	22
Density [g/mL]	1.2	1.2	1.2	1.3	1.4	1.4	1.3	1.2
Machine metering (Gamma4/Theta11)	yes	yes	yes	yes	no	yes	no	no
Fibre reinforcement	no	no	no	yes	yes	no	yes	yes
Certification	GL approval	GL approval	GL approval	no	no	no	no	no
Range of use/comments	For bonding rotor blades in wind energy plants, boat construction, bonding pipes, high dynamic loads in a large temperature range	Like 740-0110, equipped with a higher thixotropic behavior, after the application step with a bonding paste machine.	Like 740-0110, equipped with a faster reactivity	Cartridge adhesive – for structural bonding and fixation	Standard bonding paste	Standard bonding paste	Standard applications; high reactive; also for thin layers; cures tack-free	Standard bonding paste like 0588 but on an isophthalic acid base

Bonding Pastes, Fillers and High Performance Adhesives

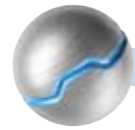

Produktname	BÜFA®-Bonding Paste 0188	BÜFA®-Bonding Paste 0600	BÜFA®-Bonding Paste 0601	BÜFA®-Bonding Paste 0650	BÜFA®-Bonding Paste 0015	BÜFA®-Bonding Paste 0072	BÜFA®-Bonding Paste 0073	BÜFA®-Bonding Paste 0590
Art. No.	740-0188	740-0600	740-0601	740-0650	740-0015	740-0072	740-0073	740-0590
Category	Standard bondings	Standard bondings	Standard bondings	Standard bondings	Sandwich constructions	Sandwich constructions	Sandwich constructions	Sandwich constructions
Resin base	THP	OP	OP	THP	OP	OP	OP	IP
Colour	blue	blue	blue	blue	blue	blue	blue	grey
Peroxidindikator	yes (blue --> green)	yes (blue --> beige)	yes (blue --> beige)	yes (blue --> beige)	yes (blue --> white)	no	yes (blue --> white)	no
Viscosity [mPa.s]	700,000	600,000	1,100,000	1,000,000	400,000	300,000	400,000	680,000
Brookfield 20 °C (U/Min)	7 / 5	7 / 5	96 / 3	95 / 5	95 / 5	95 / 5	95 / 5	7 / 5
Pre-accelerated	Co	Co	Co	Co	Co	Co	Co	Co
Peroxide	2 % by weight higher reactive MEKP	2 % by vol. medium reactive MEKP	2 % by weight higher reactive MEKP	2 % by vol. medium reactive MEKP	2 % by vol. medium reactive MEKP	2 % by vol. higher reactive MEKP	2 % by vol. medium reactive MEKP	2 % by vol. medium reactive MEKP
Gel time [min]	27	37	25	45	29	35	29	7
Curing time [min]	36	60			50	50	50	15
Density [g/mL]	0.8	1.4	1.5	1.3	0.9	0.7	0.6	0.9
Machine metering (Gamma4/Theta11)	no	no	yes	yes	no	no	no	no
Fibre reinforcement	yes	yes	no	no	no	no	no	yes
Certification	no	no	no	no	no	GL approval	GL approval	no
Range of use / comments	Bonding paste for standard bonding, filling applications (gap filling) up to 10 cm, light-weight applications in boat construction	Standard bonding paste	Standard bonding paste	Standard adhesive, impact-modified, good thixotropic stability after machine processing	Sandwich adhesive	Sandwich adhesive, boat construction	Sandwich adhesive, boat construction	Fibre reinforced, light-weight bonding paste for sandwich constructions on an isophthalic acid base

Produktname	BÜFA®-Bonding Paste 0181	BÜFA®-Bonding Paste 0182	BÜFA®-Bonding Paste 0139	BÜFA®-Bonding Paste 0141	BÜFA®-Fine Body Filler	BÜFA®-Fine Body Filler Spray	BÜFA®-Bonding Paste 0119	BÜFA®-Bonding Paste 0410
Art. No.	740-0181	740-0182	740-0139	740-0141	740-0001	740-0002	740-0119	740-0410
Category	Optimal laminate constructions	Optimal laminate constructions	Optimal laminate constructions	Optimal laminate constructions	Special bonding paste	Special bonding paste	Special bonding paste	Special bonding paste
Resin base	THP	THP	THP	THP	THP	THP	BPA/VE	IP / NPG
Colour	brown / natural	violet / natural	yellow / natural	white	grey	grey	grey / natural	violet / natural
Peroxidindikator	no	no	no	no	no	no	no	no
Viscosity [mPa.s]	140,000	550,000	1,800,000	500,000	2,250,000	23,000	1,800,000	500,000
Brookfield 20 °C (U/Min)	7 / 5	7 / 5	7 / 2	7 / 5	96 / 2,5	6 / 5	7 / 2	95 / 5
Pre-accelerated	Co	Co	Co / Amine	Co / Amine	Co / Amine	Co	Co	Co
Peroxide	2 % by vol. medium reactive MEKP	2 % by vol. medium reactive MEKP	2 % by vol. medium reactive MEKP	2 % by vol. medium reactive MEKP	2 % by vol. medium reactive MEKP	2 % by vol. medium reactive MEKP	2 % by vol. medium reactive MEKP	2 % by vol. medium reactive MEKP
Gel time [min]	33	15	35	20	15	8	35	24
Curing time [min]	44	30		34	32	16		42
Density [g/mL]	1.3	1.2	1.3	1.3	1.8	2.5	1.4	1.2
Machine metering (Gamma4/Theta11)	no	no	no	no	no	yes	no	yes
Fibre reinforcement	yes	yes	yes	yes	no	no	yes	no
Certification	no	no	GL approval	GL approval	no	no	GL approval	no
Range of use / comments	Standard applications; also suitable as a levelling resin compound; "liquid laminate" low-shrink, higher fibre content	Levelling compound ("liquid laminate")	Elastic, universal bonding paste for many applications	Elastic, universal bonding paste for many applications	model-making with good smoothing and sanding properties	Spray filler for model-making with good sanding properties	VE Bonding Paste with a HDT form 105°C.	For chemical resistant applications; also very suitable for joining rigid PVC

Abbreviations for resin base: VE – vinyl ester, OP – orthophthalic acid, IP – isophthalic acid, THP – tetrahydrophthalic acid, NPG – neopentyl glycol – BPA – bisphenol A

Bonding Pastes, Fillers and High Performance Adhesives

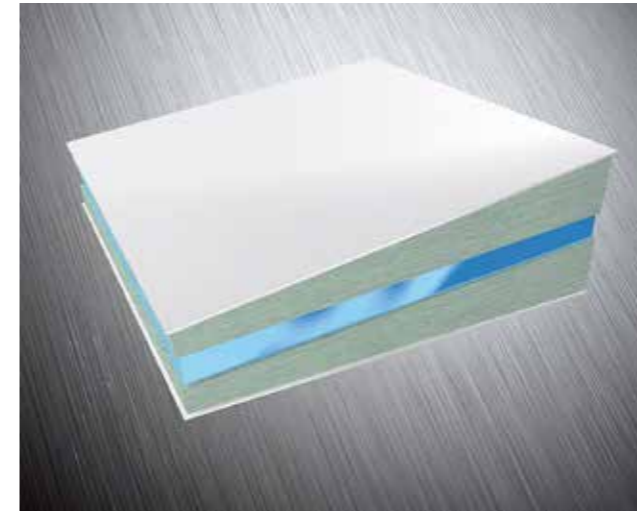
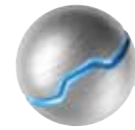

Structural and standard bondings

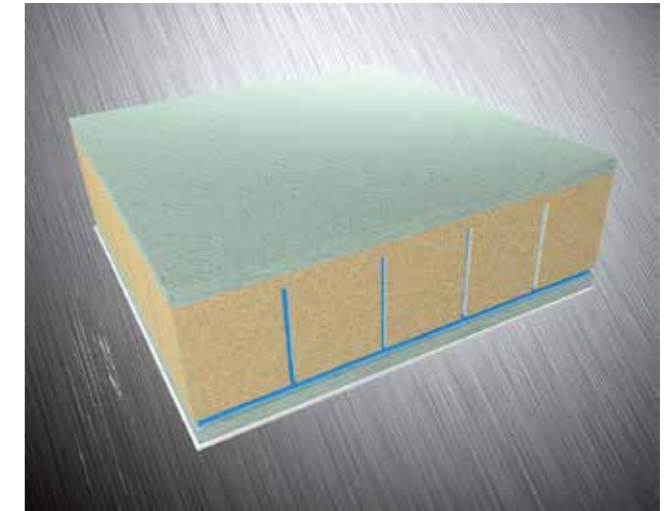

Sandwich constructions

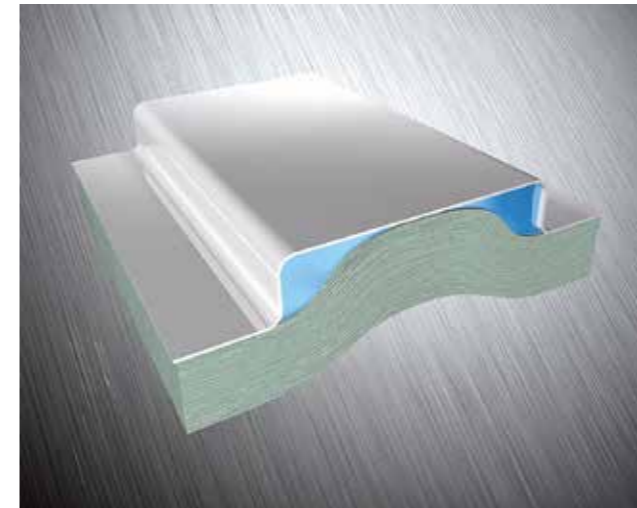

Optimal laminate constructions

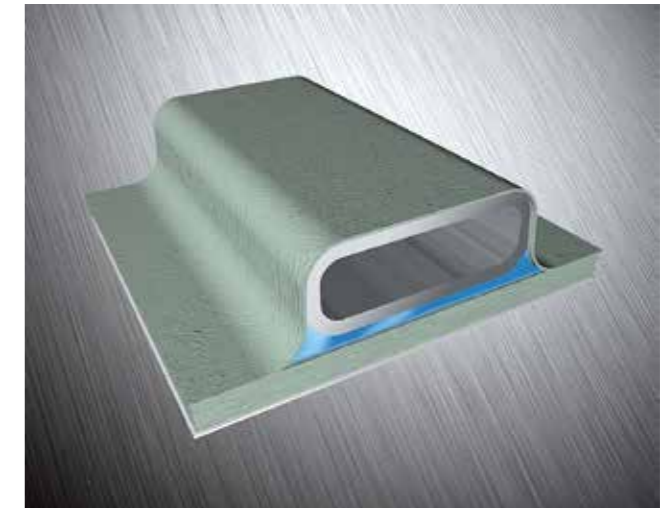

Bonded joints with metal and wood



High strength bondings

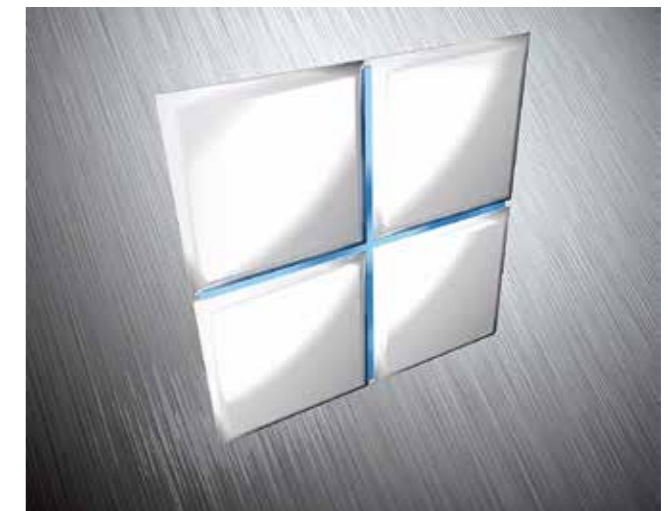

Special bonding pastes

Bonding Pastes, Fillers and High Performance Adhesives

Find the appropriate product solution for your application in our extensive range of products.

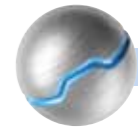

Category	Art. No.	Product name	Description	Resin base	Range of use / comments	Marine						Rail vehicles		Automotive		Other		
						Repair	Deck + hull	Interior walls	Sandwich constructions	Inliner + hull	Deck + inside roof lining	Levelling	Sandwich constructions	Structural bonding	Sandwich constructions	Structural bonding	Levelling	Mould construction
For high strength bondings	740-0110	BÜFA®-Bonding Paste 0110	Bonding paste with outstanding mechanical and chemical properties	BPA/VE	For bonding rotor blades in wind energy plants, boat construction, bonding pipes, high dynamic loads in a large temperature range		✓	✓		✓	✓			✓		✓	✓	✓
	740-0111	BÜFA®-Bonding Paste 0111	Bonding paste with outstanding mechanical and chemical properties, equipped with a higher thixotropic behavior, after the application step with a bonding paste machine	BPA/VE	For bonding rotor blades in wind energy plants, boat construction, bonding pipes, high dynamic loads in a large temperature range		✓	✓		✓	✓			✓		✓	✓	✓
	740-0114	BÜFA®-Bonding Paste 0114	Bonding paste with outstanding mechanical and chemical properties, like 740-0110 but with a shorter gel time	BPA/VE	Boat construction, bonding pipes, high dynamic loads in a large temperature range		✓	✓		✓	✓			✓		✓	✓	✓
For structural bondings	660-0001	BÜFA®-Bond 001	Cartridge adhesive (10 to 1 - BPO/amine curing)	/	Cartridge adhesive – for structural bonding and fixation	✓							✓		✓			
	740-0185	BÜFA®-Bonding Paste 0185	Bonding paste with very good mechanical properties, good thixotropy	THP	Standard bonding paste			✓		✓	✓							
	740-0250	BÜFA®-Bonding Paste 0250	Bonding paste with a wide application spectrum	OP	Standard bonding paste			✓						✓				
	740-0588	BÜFA®-Bonding Paste 0588	Bonding paste with good mechanical properties, good thixotropy	THP	Standard applications, high reactive, also for thin layers, cures tack-free			✓						✓		✓		
	740-0591	BÜFA®-Bonding Paste 0591	Bonding paste with a wide application spectrum	IP	Standard bonding paste like 0588 but on an isophthalic acid base		✓								✓			
For standard bondings	740-0188	BÜFA®-Bonding Paste 0188	Bonding paste for thicker layers (up to 10 cm) with low density, good thixotropy	THP	Bonding paste for standard bonding, filling applications (gap filling) up to 10 cm, light-weight applications in boat construction			✓			✓	✓				✓		
	740-0600	BÜFA®-Bonding Paste 0600	Bonding paste for versatile use, medium gel time	OP	Standard bonding paste			✓								✓		
	740-0601	BÜFA®-Bonding Paste 0601	Bonding paste for versatile use, medium gel time	OP	Standard bonding paste			✓								✓		
	740-0650	BÜFA®-Bonding Paste 0650	Bonding paste with a wide application spectrum	THP	Standard adhesive, impact-modified, good thixotropic stability after machine processing		✓	✓				✓						
For sandwich constructions	740-0015	BÜFA®-Bonding Paste 0015	Sandwich bonding paste with low density	OP	Sandwich adhesive				✓		✓	✓		✓				
	740-0072	BÜFA®-Bonding Paste 0072	Sandwich bonding paste with low density	OP	Sandwich adhesive, boat construction				✓			✓		✓				
	740-0073	BÜFA®-Bonding Paste 0073	Sandwich bonding paste with low density	OP	Sandwich adhesive, boat construction				✓		✓	✓		✓				
	740-0590	BÜFA®-Bonding Paste 0590	Light-weight sandwich adhesive	IP	Fibre reinforced, light-weight bonding paste for sandwich constructions on an isophthalic acid base				✓			✓		✓				
For optimal laminate constructions	740-0181	BÜFA®-Bonding Paste 0181	Standard applications; also very suitable as a levelling resin compound; "liquid laminate", low-shrink, higher fibre content	THP	Standard applications, also suitable as a levelling resin compound, "liquid laminate" low-shrink, higher fibre content						✓					✓		
	740-0182	BÜFA®-Bonding Paste 0182	Liquid laminate with higher exothermic character, high viscosity	THP	Levelling compound ("liquid laminate")						✓		✓			✓		
Bonded joints with metal and wood	740-0139	BÜFA®-Bonding Paste 0139	Bonding paste for joining metal and wood, elastic	THP	Elastic, universal bonding paste for many applications			✓					✓		✓			
	740-0141	BÜFA®-Bonding Paste 0141	Bonding paste for joining metal and wood, elastic	THP	Elastic, universal bonding paste for many applications			✓					✓		✓			
Special bonding pastes	740-0001	BÜFA®-Fine Body Filler	Repair filler formulated for brushing	THP	Fine filler for model-making with good smoothing and sanding properties	✓										✓		
	740-0002	BÜFA®-Fine Body Filler Spray	Repair filler formulated for spraying	THP	Spray filler for model-making with good sanding properties	✓										✓		
	740-0119	BÜFA®-Bonding Paste 0119	VE Bonding Paste with a HDT form 105°C.	BPA/VE	For chemical resistant applications like pipe and tank constructions, for applications where a high HDT plays an important role.													✓
	740-0410	BÜFA®-Bonding Paste 0410	Chemical resistant bonding paste, good adhesion to PVC hard	IP/NPG	For chemical resistant applications, also very suitable for joining rigid PVC hard													✓

The recommendations presented above are a few of the possibilities for using bonding pastes. For more detailed information, please get in touch with our Technical Service Department.

Abbreviations for base resins: VE – vinyl ester, OP – orthophthalic acid, IP – isophthalic acid, THP – tetrahydrophthalic acid, NPG – neopentyl glycol – (✓) = Please get in touch with our Technical Service Department.

Bonding Pastes, Fillers and High Performance Adhesives

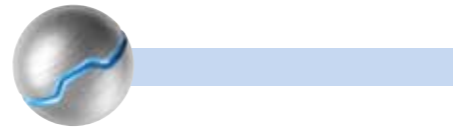

The following table will help you to find the right adhesive for your application. All materials marked with a check can be fixed with the respective adhesive, e.g. MA 300 Gelcoats, GRP, aluminium, stainless steel, etc..

Plexus Construction Adhesive for boats	Plexus Construction Adhesive for utility vehicles	Plexus Construction Adhesive for motor vehicles	Plexus Construction Adhesive for technical applications
Stronger bonding than the laminate	Fast cure at room temperature, saves production time	Fast processing	Cures at room temperature
Reduces the formation of cracks and hair cracks in the gelcoat	Resistant to oil and diesel fuel	Bonds to different substrates	Outstanding properties when bonding different substrates
Different processing and fixing times, appropriate for all applications	Bonds to different types of substrates / materials	High strength and extremely durable	Processing and fixing time appropriate for all applications
Joint thicknesses up to 37 mm possible	Practically no pre-treatment of the surface	Proven applications	Highly UV resistant
	Easy to use		Excellent chemical resistance
	Outstanding fatigue strength		

PLEXUS high performance adhesive is suitable for a number of applications, however, we expressly point out that we cannot give any guarantee whatsoever in regard to processing or the resulting final products.

Due to the many variables of materials and surfaces, we recommend testing all substrates under the expected conditions of use before actually using to ensure correct application.

If you have any further questions concerning the PLEXUS products and how they are used, please get in contact with us.

Overview of Plexus products

Product name	MA300	MA310	MA420	MA422	MA425	MA530	MA590	MA830	MA832	MA920
Art. No.	019-1300	019-1310	019-0420	019-0422	019-0425	019-0530	019-0592	019-0830	019-0832	019-0922
Colour	Cream	Cream / Grey	Blue / Black	Blue	Blue	Grey	Grey	Grey	Grey	Blue
Mixing ratio [vol]	1:1	1:1	10:1	10:1	10:1	1:1	1:1	10:1	10:1	10:1
Viscosity [mPa·s]	A: 40.000-60.000 B: 40.000-60.000	A: 40.000-60.000 B: 40.000-60.000	A: 100.000-125.000 B: 25.000-35.000	A: 100.000-125.000 B: 40.000-60.000	A: 100.000-125.000 B: 40.000-60.000	A: 160.000-180.000 B: 175.000-210.000	A: 175.000-220.000 B: 175.000-210.000	A: 90.000-120.000 B: 25.000-35.000	A: 90.000-120.000 B: 25.000-35.000	A: 100.000-125.000 B: 25.000-35.000
Working time [min]	4-6	15-18	4-6	17-24	30-35	30-35	90-105	4-6	12-16	4-6
Fixing time [min]	12-15	30-35	15-18	35-40	80-90	90-160	210-270	20-25	50-60	15-18
Tensile strength [MPa]	20.6-24.1	20.6-24.1	12.0-15.5	10.3-12.4	10.3-12.4	13.1-15.2	9.6-12.4	15.8-19.3	18.8-19.3	10.3-13.7
Elongation [%]	15-25	5-15	100-125	75-100	120-140	130-170	130-160	30-60	30-60	80-100
Joint thickness [mm]	4	4	8	10	10	18	37	12	12	10
Description	All-purpose adhesive, high strength	Ideal for "plastics that are difficult to bond"	All-purpose adhesive with good toughness	All-purpose adhesive with medium working time	All-purpose adhesive with long working time	All-purpose adhesive, high pressure with medium working time	Marine, for bonding larger structural components	All-purpose adhesive, high strength/high toughness	All-purpose adhesive, high strength/high toughness	Versatile use, low odour

Bonding Pastes, Fillers and High Performance Adhesives



Product name	MA300	MA310	MA420	MA422	MA425	MA530	MA590	MA830	MA832	MA920
Art. No.	019-1300	019-1310	019-0420	019-0422	019-0425	019-0530	019-0592	019-0830	019-0832	019-0922
Metal										
Aluminium	✓		✓	✓	✓			✓	✓	✓
Brass										
Cast iron		✓						✓	✓	
Copper										
Ferrites										
Lacquered/coated metals	✓	✓	✓	✓	✓	✓	✓	✓	✓	✓
Clad metals		✓	✓					✓	✓	
Sheet metal	✓	✓	✓					✓	✓	
Stainless steel	✓		✓	✓	✓			✓	✓	✓
Cold-rolled steel	✓	✓	✓					✓	✓	
Galvanised metals								✓	✓	
Plastics										
ABS	✓	✓	✓	✓	✓	✓	✓	✓	✓	✓
Acrylates (PMMA)	✓	✓	✓	✓	✓	✓	✓	✓	✓	✓
Polyamides		✓								
Thermoplastic polyesters (PBT, PET)	✓	✓	✓	✓	✓	✓	✓	✓	✓	✓
Polycarbonates										
Vinyl plastics (PVC)	✓	✓	✓	✓	✓	✓	✓	✓	✓	✓
Polyurethanes	✓	✓	✓	✓	✓					
Composite materials										
Fibre glass	✓	✓	✓	✓	✓	✓	✓	✓	✓	✓
Gelcoats	✓	✓	✓	✓	✓	✓	✓	✓	✓	✓
SMC	✓	✓	✓	✓	✓					✓
Phenol resin	✓	✓	✓							
Laminates	✓	✓	✓	✓	✓	✓	✓			
RTM	✓	✓	✓	✓	✓	✓	✓	✓	✓	✓
Other										
Rubber		✓								

Also available PC120 Priming Lacquer – reinforces the bonding properties and durability of Plexus adhesives when aluminium and stainless steel are bonded (does not prevent the formation of rust).

BÜFA®-Bond 001

High process reliability is ensured with the ready-to-use cartridge adhesive, BÜFA®-Bond 001. Metering, mixing and application take place in just one working operation.



The cartridge adhesive BÜFA®-Bond 001 is glass fibre reinforced and easy to meter. It has outstanding chemical resistance, cures tack-free, is highly thixotropic and therefore highly stable. In addition, BÜFA®-Bond 001 contains a peroxide indicator. The maximum thickness of the adhesive layer is 8 mm.

It is mainly used for joining GRP / GRP, aluminium and steel substrates, for structural bonding and fast fixation but also for other special applications.

Application:

Art. No.: 026-0400 Hand dosing gun
Art. No.: 019-0205 Pneumatic gun

Sales unit:

Art. No.: 660-0001 BÜFA®-Bond 001

1/1 – unit/carton

This article contains:

- 6 cartridges
- 6 static mixers



Art. No.:
026-0400



Art. No.:
019-0205

Your Advantages:

- "Ready-to-use" and thus high process reliability
- Metering, mixing and application in just one working operation
- Material is quickly and selectively applied – saves material / reduces waste
- Little VOC, no half-empty, leftover containers
- Insensitive to fluctuations in temperature and humidity
- BP / amine curing concept
- Long shelf-life of 4 months (20 °C)

Accessories:

Individual: Art. No.: 029-4686 Static Mixer
12 in a package: Art. No.: 029-4763 Static Mixer

BÜFA®-Bond 001

Cartridge Solutions

Product name	BÜFA®-Bond 001	
Art. No.	660-0001 1/1	Resin base: IP: isophthalic acid OP: orthophthalic acid THP: tetrahydrophthalic acid VE: vinyl ester NPG: neopentyl glycol BPA: bisphenol A Reactivity: Measured on a 100 g sample at 20 °C Gel time: Time from 20 °C - 30 °C (mean value) = 11 min Curing time: Time from 20 °C - Tmax (mean value) = 15 min Viscosity: 600,000 mPas
Resin base	cartridge adhesive (380mL)	
Viscosity [mPa.s]	580,000	
Colour	green	
Peroxide indicator	yes (green --> white)	
Peroxide	forced mixing - resin / hardener = 10 to 1	
Pre-accelerated	BPO / amine (pre-assembled)	
Gel time [min]	10	
Curing time [min]	14	
Density [g/mL]	1.3	
Fibre reinforcement	yes	
Certification	no	
Range of use / comments	cartridge adhesive – for structural bonding and fixation	



Copyright: Voth-Turbo GmbH & Co. KG



UNLIMITED COLOURS

Pigment Pastes

Composites



A selection of available shades of colour

Art. No.	BÜFA®-Pigment Paste	Art. No.	BÜFA®-Pigment Paste
730-1001	Beige 10001	730-6005	Moss green 60005
730-1004	Gold yellow 10004	730-6010	Gras green 60010
730-1011	Brown beige 10011	730-6011	Reseda green 60011
730-1015	Light ivory 10015	730-6014	Yellow olive 60014
730-1016	Sulphur yellow 10016	730-6019	White green 60019
730-2002	Blood orange 20002	730-7000	Squirrel grey 70000
730-2004	Pure orange 20004	730-7001	Silver grey 70001
730-3000	Fire red 30000	730-7005	Mouse grey 70005
730-3004	Purple red 30004	730-7016	Anthracite grey 70016
730-3007	Black red 30007	730-7032	Pebble grey 70032
730-3015	Light pink 30015	730-7035	Light grey 70035
730-4001	Red violet 40001	730-8001	Ochre brown 80001
730-4006	Traffic purple 40006	730-8007	Fawn brown 80007
730-4010	Telemagenta 40010	730-8023	Orange brown 80023
730-5002	Ultramarine 50002	730-9001	Cream white 90001
730-5007	Brilliant blue 50007	730-9010	Pure white 90010
730-5010	Enzian blue 50010	730-9016	Traffic white 90016
730-5012	Light blue 50012	743-1007	Daffodil yellow 10007
730-5015	Sky blue 50015	743-1018	Zinc yellow 10018
730-6001	Emerald green 60001	743-5002	Ultramarine 50002
730-6002	Leaf green 60002	743-9005	Deep black 90005

Composition:

BÜFA®-Pigment Pastes are grinds of high quality, organic and inorganic pigments and special unsaturated polyester resins.

Organic pigments are, e.g. Azo pigments, phthalocyanines and chinacridones; the inorganic are, e.g. titanium dioxide, iron oxides and bismuth vanadate.

BÜFA®-Pigment Pastes are free of mercury, lead, cadmium and chromates (Cr VI).

The pigments used are – opposite dyes – insoluble in the application medium, in water as well as in most solvents, acids and lyes.

All of the pigments we use meet the highest requirements on light fastness and weather fastness.

An important advantage of our BÜFA®-Pigment Pastes is that they cover the entire colour spectrum.

With our more than 25 full strength colours, practically any desired colour can be reproduced.

Along with the more than 100 standard shades of colour, a good number of nuances can also be supplied.

Even special shades of colours desired by our customers can be reproduced without any problems.

On request the pigment pastes are also available in different carrier systems, e.g. epoxy or acrylate resins, solvents, etc.

Pigment Pastes

BÜFA®-Pigment Pastes

BÜFA®-Pigment Pastes are grinds of high quality pigments in various carrier systems.

Our BÜFA®-Pigment Pastes are based on unsaturated polyester resins in low monomer (article group 730) and monomer-free (article group 743, MF) formulations.

BÜFA®-Pigment Pastes can be used to tint gelcoats and top-coats as well as laminating and casting resins on a UP and VE base.

Neolite Pigment Pastes

Neolite pigment pastes are coloured liquid/pastes based on a combination of tinters. These tinters consist of pigment dispersed into a solvent free reactive polyester resin.

The pigments used have been carefully selected based on colour fastness, opacity, heat stability and having minimum effect on the curing characteristics of the final system.

Available in a wide range of colours, they have been developed to blend easily into resin systems. The viscosity of the pastes is such that they are all pumpable.

Article group	730/743	730/743
Shade of colour	White	Yellow
Quantity added to gelcoat	15-20 %	15-20 %

Article group	730/743	730/743
Shade of colour	Orange/Red	Blue
Quantity added to gelcoat	15-20 %	10 %

Article group	730/743	730/743
Shade of colour	Green	Grey
Quantity added to gelcoat	10 %	10-15 %

Article group	730/743	730/743
Shade of colour	Brown	Black
Quantity added to gelcoat	10 %	10 %

Our colour sample card, which is available on request, provides a detailed and clear view of our standard programme.



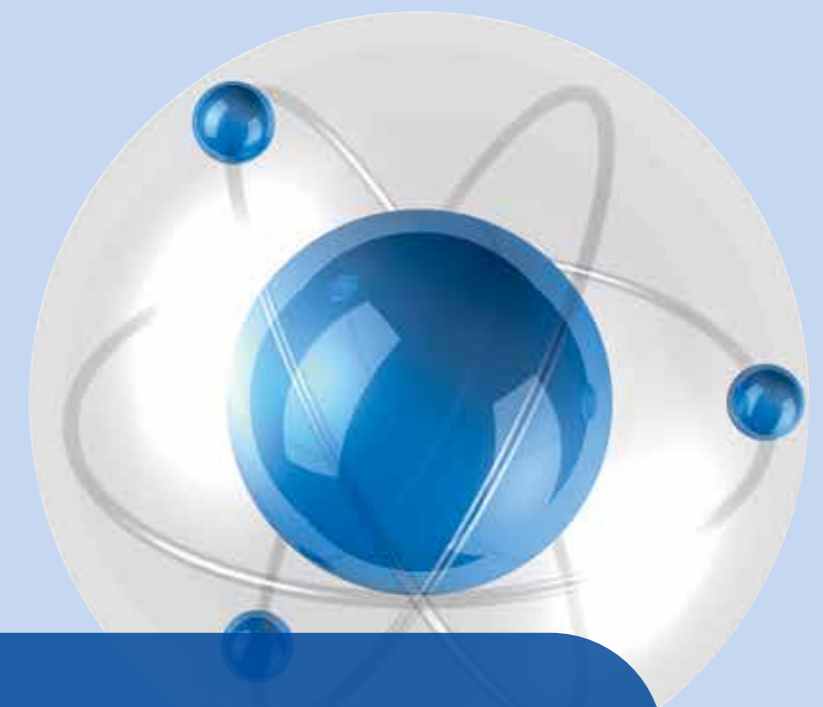

IDEAL CROSS-LINKING

Initiators



Initiators

Working with reactive resins begins with the addition of initiators. Hardeners, accelerators as well as inhibitors must be exactly coordinated to each other if the desired effect and optimum polymerisation and curing are to be achieved. Our peroxides from United Initiators meet the highest possible quality and safety requirements. Combined with the right BÜFA accelerators and inhibitors, the user can individually adjust curing reactions to his working conditions as well as the requirements placed on the final product.

Our partner for organic peroxides, United Initiators, concentrates exclusively on the development and production of peroxides. The main office and production plant for the European market are located in Germany. United Initiators was the first company to produce 100 % phthalate-free peroxides in Europe, thus contributing to their goal of sustainability.

The products are distinguished by a high quality standard and product safety and their line of products is outstandingly coordinated to your applications.

Important Note:

Hardeners, accelerators and, if applicable, inhibitors must be exactly coordinated to each other if the desired effect is to be achieved. The selection of the optimum cold curing system depends on working conditions as well as the requirements placed on the finished product.

Attention:

It is exceedingly important that peroxides and accelerators are never stirred into the resin at the same time but one after the other to prevent fires or deflagration.

Let us to give you good advice.

Accelerators on a co-octoate base

- Accelerates curing
- For curing UP and VE resins
- For use with ketone peroxide

Product name	BÜFA®-Accelerator Co 1	BÜFA®-Accelerator Co 2	BÜFA®-Accelerator Co 4	BÜFA®-Accelerator Co 6	BÜFA®-Accelerator Co 10
Art. No.	742-0062	742-0042	742-0065	742-0600	742-0072
Chemical composition	cobalt-octoate, 1% dissolved in styrene and xylene	cobalt-octoate, 2% dissolved in styrene and xylene	cobalt-octoate, 4% dissolved in styrene and xylene	cobalt-octoate, 6% dissolved in xylene	cobalt-octoate, 10% dissolved in xylene
	Easy to meter because of the low concentration				

Accelerators on an amine base

- Optimises curing
- For curing UP and VE resins
- Improves curing in high humidity and at low temperatures
- For use with benzoyl peroxide
- Easy to meter because of the low concentration

Product name	BÜFA®-Accelerator DEA 10	BÜFA®-Accelerator DMA 10
Art. No.	742-0083	742-0060
Chemical composition	dimethyl aniline, 10% dissolved in styrene	dimethyl aniline, 10% dissolved in styrene

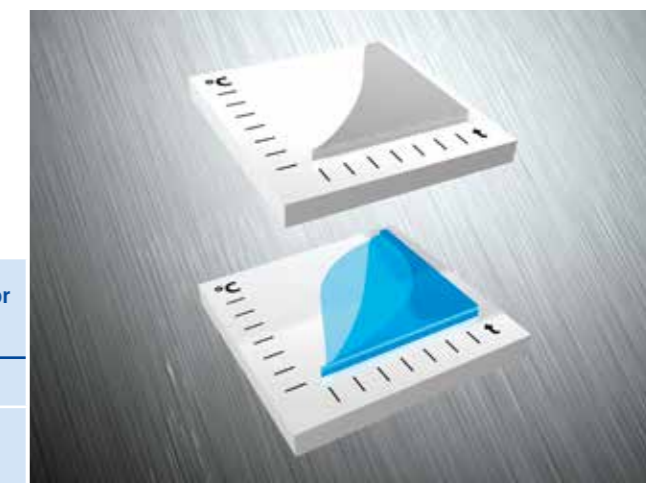

New accelerator series based on polymeric cobalt

Product name	BÜFA®-Accelerator Complex 0061	BÜFA®-Accelerator Complex 0071	BÜFA®-Accelerator Complex 0095	BÜFA®-Accelerator Complex 0096	BÜFA®-Accelerator Complex 0097
Art. No.	742-0061	742-0071	742-0095	742-0096	742-0097
Chemical composition	Polymeric cobalt 1%, dissolved in monomer-free resin	Polymeric cobalt 1%, dissolved in styrene and xylene	Polymeric cobalt 2%, dissolved in styrene and xylene	4% polymeric cobalt	cross accelerator polymeric cobalt/dimethyl aniline dissolved in xylene

Product name	BÜFA®-Accelerator Complex 0098	BÜFA®-Accelerator Complex 0099	BÜFA®-Accelerator Complex 0397	BÜFA®-Accelerator Complex 9004	
Art. No.	742-0098	742-0099	742-0397	715-9004	
Chemical composition	Accelerator complex for curing VE resins	Accelerator complex for curing UP and VE resins with reduced Tmax	cross accelerator polymeric cobalt/DEAA dissolved in xylene	Accelerator complex for curing highly filled fire protection systems	



Ketone peroxides

Product name	Curox M-102	Curox M-103	Curox M-303	Curox M-303 R	Curox M-312	Curox M-312 R	Curox M-402	Curox M-402 R	Curox M-403	Curox M-503	Curox A-300	Curox A-300 R	Curox I-200	Curox I-300
Art. No.	021-0033	021-0023	021-0053	021-0056	021-0034	021-0037	021-0035	021-0036	021-0021	021-0025	021-0030	021-0020	021-0031	021-0061
Properties	Low reactive MEKP, phthalate-free	Low reactive MEKP	Standard, medium reactive MEKP	Standard, medium reactive MEKP with red indicator,	Standard, medium reactive MEKP phthalate-free	Standard, medium reactive MEKP with red indicator, phthalate-free	High reactive MEKP phthalate-free	High reactive MEKP with red indicator phthalate-free	High reactive MEKP	High reactive MEKP	Standard AAP	Standard AAP with red indicator	Standard MIKP	High reactive MEKP
Active oxygen content [%]	8.6	8.9	9.1	9.1	8.9	8.9	9.8	9.8	9.7	9.5	4.1	4.1	10.7	10.5
Packaged form	liquid	liquid	liquid	liquid	liquid	liquid	liquid	liquid	liquid	liquid	liquid	liquid	liquid	liquid
Hand lay-up and spray-up	✓	✓	✓	✓	✓	✓	✓	✓	✓	✓	✓	✓	✓	
RTM	✓	✓	✓	✓	✓	✓	✓	✓	✓	✓	✓	✓		
Polymer concrete & marble			✓	✓	✓	✓	✓	✓	✓	✓	✓	✓	✓	✓
Gelcoats	✓	✓	✓		✓		✓		✓	✓				
Filling compounds			✓	✓	✓	✓			✓					
Chemical dowels & anchor bolts														
Coatings	✓	✓											✓	✓
Buttons	✓	✓	✓	✓	✓	✓	✓	✓	✓	✓			✓	✓
Elevated temperature														
Centrifugal casting			✓	✓	✓	✓	✓	✓	✓	✓				
Filament winding	✓	✓	✓	✓	✓	✓	✓	✓	✓	✓			✓	✓
Continuous sheet production	✓	✓	✓	✓	✓	✓	✓	✓	✓	✓	✓	✓	✓	✓
High temperature														
Pultrusion													✓	✓
Hot press moulding														
Vinylester														
Special resins	✓	✓											(✓)	(✓)
Acrylic resins														

(✓): Please get in touch with our Technical Service Department



Initiators



Dibenzoyl peroxides

Product name	BP-50-FT1	Hardener BPO White	Benox L-40LV	BP-40SAQ
Art. No.	021-7001	021-2326	021-0062	021-0047
Properties	BPO powder for standard applications, "free flowing"	Standard BPO-Paste	BPO-dispension 40%	BPO-suspension 40%
Active oxygen content [%]	3.3	3.3	2.6	2.6
Packaged form	powder	paste	dispension	suspension
Hand lay-up and spray-up	✓	✓	✓	✓
RTM	✓		✓	✓
Polymer concrete & marble	✓		✓	✓
Gelcoats				
Filling compounds		✓	✓	✓
Chemical dowels & anchor bolts	✓	✓	✓	✓
Coatings			✓	✓
Buttons				
Elevated temperature				
Centrifugal casting				
Filament winding				
Continuous sheet production				
High temperature				
Pultrusion	✓			
Hot press moulding				
Vinylester				
Special resins	✓		✓	✓
Acrylic resins			✓	✓

(✓): Please get in touch with our Technical Service Department

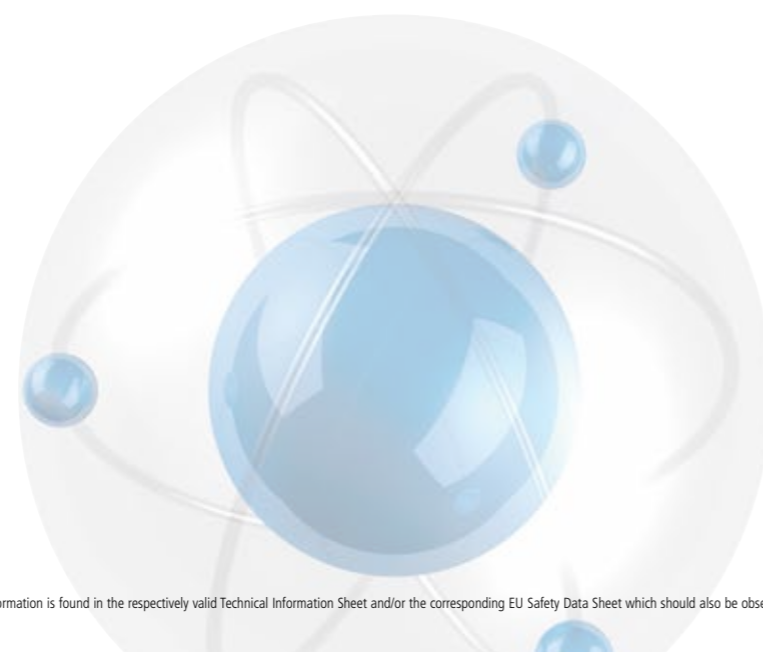

Initiators



Perester

Product name	TBPB	TBPB-HA-M1	TBPEH	TBPIN
Art. No.	021-0048	021-0049	021-0043	021-0042
Properties	>98 % tert. butyl peroxybenzoate	tert. butylperoxybenzoate/ promoter	tert.-Butyl-2-ethylperoxyhexanoat	tert.-Butylperoxy-3,5,5-trimethylhexanoat
Active oxygen content [%]	8.1	7.4	7.3	6.9
Packaged form	liquid	liquid	liquid	liquid
Hand lay-up and spray-up				
RTM	✓	✓		
Polymer concrete & marble				
Gelcoats				
Filling compounds				
Chemical dowels & anchor bolts				
Coatings				
Buttons				
Elevated temperature				
Centrifugal casting				
Filament winding				
Continuous sheet production				
High temperature				
Pultrusion	✓	✓	✓	✓
Hot press moulding	✓	✓	✓	✓
Vinylester				
Special resins	✓	✓		✓
Acrylic resins				



Initiators

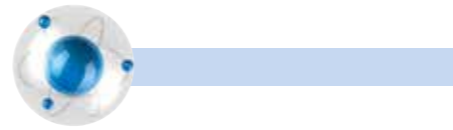

Peroxide Mixtures

Product name	Curox M-372	Curox CM-75	Curox CM-75 R	
Art. No.	021-0038	021-0070	021-0071	MEKP=
Properties	MEKP/AAP-mixture, phthalate-free	CuHP + MEKP	CuHP + MEKP	Methylethylketonperoxid
Active oxygen content [%]	7.4	8.9	8.9	AAP=
Packaged form	liquid	liquid	liquid	Acetylacetonperoxid
Hand lay-up and spray-up	✓	✓	✓	
RTM	✓	✓	✓	COX=
Polymer concrete & marble	✓			Cyclohexanonperoxid
Gelcoats				
Filling compounds				MIKP=
Chemical dowels & anchor bolts				Methylisobutylketonperoxid
Coatings	✓			
Buttons				BPO=
Elevated temperature				Dibenzoylperoxid
Centrifugal casting	✓			
Filament winding	✓	✓	✓	CuHP=
Continuous sheet production	✓			Cumolhydroperoxid
High temperature				
Pultrusion				
Hot press moulding				
Vinylester				
Special resins		✓	✓	
Acrylic resins				



Initiators



Perketals

Product name	CH-50-AL	CH-80-AL	TMCH-50-AL	Other
Art. No.	021-0039	021-0040	021-0045	BCHPC
Properties	Standard perketal for long storage stability of the mixture 50% solution	Standard perketal for long storage stability of the mixture 80% solution	Standard perketal for long storage stability of the mixture 50% solution	High reaktive percarbonate
Active oxygen content [%]	6.1	9.7	5.3	3.8
Packaged form	liquid	liquid	liquid	powder
Hand lay-up and spray-up				
RTM				
Polymer concrete & marble				
Gelcoats				
Filling compounds				
Chemical dowels & anchor bolts				
Coatings				✓
Buttons				
Elevated temperature				
Centrifugal casting				
Filament winding				
Continuous sheet production				
High temperature				
Pultrusion	✓	✓	✓	✓
Hot press moulding	✓	✓	✓	✓
Vinylester				
Special resins				
Acrylic resins				✓



Instructions for Handling and Storing Initiators safety

Storage

Unless stated otherwise on the label, organic peroxides should be stored in the original container at a temperature of max. 25 °C. Protect organic peroxide from all sources of heat, including direct sunlight. Peroxides may never be stored together with other chemicals, especially accelerators as well as reducing agents and combustible products.

Measures against the Risk of Fire

Do not smoke, no open light, no sparks or other sources of ignition.

Risk of Explosion

Avoid direct contact of organic peroxides with accelerators; each component should be added to the resin separately. Prevent contamination from dust, heavy metals and their compounds as well as chemicals.

Eye and Skin Injuries

Always wear protective glasses and protective gloves since organic peroxides can burn skin and eyes.



PROCESS SOLUTIONS

Release Agents, Additives & Ancillaries

Composites



BÜFA®-Release Agents

Product name	BÜFA®-Release Agent for Metal moulds	BÜFA®-Release Laquer Nature	BÜFA®-Release Wax Paste	BÜFA®-Release Wax Liquid	BÜFA®-Mould Cleaner 3125
Art. No.	741-0070	741-0052	741-0054	741-0063	742-0596
Characteristics	Based on soybean lecithin dissolved in butyl acetate Mould release agent for moulds made of pore-free materials (steel, glass, etc.)	Based on polyvinyl alcohol dissolved in ethanol/water Mould release agent for use on plastic moulds, glossy after drying, tough, PVA layer	Based on synthetic wax and white spirit When used on moulds made of plastic, wood, gypsum, etc., mainly used with the release lacquer BÜFA®-Release Lacquer Nature	Based on polyethylene wax dissolved in white spirit When used on complicated moulds made of plastic, wood, gypsum, etc., also often used with the release lacquer BÜFA®-Release Lacquer Nature	Based on butyl acetate, toluene-free Highly effective cleaner for removing wax and polyester residue from mould surfaces

Product name	BÜFA®-BF 500 Liquid mould release wax	BÜFA®-BF 700 Mould release wax paste
Art. No.	022-0500	022-0700
Characteristics	Liquid release wax, toluene-free	Release wax paste, without silicone



Release Agents, Additives and Ancillaries

BÜFA

As manifold as procedures and methods of processing are, BÜFA's portfolio of release agents, additives and auxiliary agents is just as varied. In the following pages of this brochure, we would like to present a selection of our line of products.

BYK

Along with our BÜFA products, Byk additives in particular are also available to users. The use of Byk additives optimises your production sequences and improves the quality of your finished products.

Byk additives are already in many BÜFA products. The following table provides information on our most important additives for de-airing, wetting and dispersing as well as surface and rheology additives.

Chem Trend

Chem Trend is the world-wide leading manufacturer of release agents for the most different industrial applications, e.g. composite materials, plastic and rubber applications.

Would you like to optimise your production and make processes more efficient?

Then the semi-permanent release agent systems made by Chem Trend offers you the right solution.

BÜFA®-Primer

Product name	BÜFA®-Primer Metal	BÜFA®-Primer Wood	BÜFA®-Primer Polymere concrete	BÜFA®-Resin UP 0122
Art. No.	742-0079	742-0074	742-0078	700-0122
Characteristics	Based on a special silane acrylate dissolved in alcohol Used as a bonding layer when coating metal, glass and ceramic with GRP	Based on aromatic polyisocyanate in organic solvents Used as a bonding layer when coating wood surfaces with GRP	Based on a special silane acrylate dissolved in alcohol Improves mechanical properties in concrete applications. Improves adhesion on glass fibres	Unsaturated polyester dissolved in styrene Optimises adhesion on PVC

BÜFA®-Additive Viscosity Control

Product name	BÜFA®-Additive Spray thinner	BÜFA®-UP Thixpaste	BÜFA®-Additive Viscoreducer
Art. No.	742-0013	740-0007	742-0018
Characteristics	Specially coordinated mixture of acetone and styrene Optimises the spraying viscosity of gelcoats	Mixture of thixotropizing agents in UP resin For thixotropizing UP resins, paste consistence, easy to meter (5 - 20 %) and work in	Styrene-free solution of polymers in MMA For reducing the viscosity of filled systems to improve working properties or the degree of filling

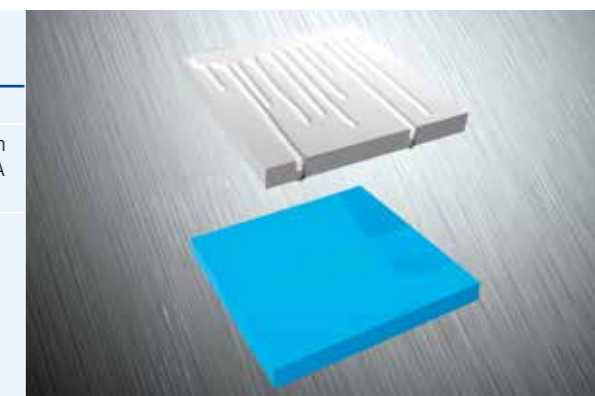

Release Agents, Additives and Ancillaries

LSE Control

Product name	BÜFA®-Additive LSE	BÜFA®-Paraffine Solution 2,5	BÜFA®-Paraffine Solution 6	BÜFA®-Paraffine Solution 10
Art. No.	742-0077	742-2025	742-2060	742-0082
Characteristics	Milieu additive dissolved in styrene	2.5 % paraffin solution in styrene and xylene	6 % paraffin solution in styrene and xylene	10 % paraffin solution in styrene and xylene
	An alternative to paraffin wax to reduce the emission of styrene, contains an adhesion promoter, can be over-laminated – see information in Technical Data Sheet	For tack-free curing of UP resins. Effective at temperatures between 18 - 32 °C	For tack-free curing of UP resins. Effective at temperatures between 18 - 32 °C	For tack-free curing of UP resins. Effective at temperatures between 18 - 32 °C



Further Additives

Product name	BÜFA®-Lubricant ST	BÜFA®-Accelerator Foaming Agent
Art. No.	742-0002	020-0880
Characteristics	Special lubricant based on sulphonic acid ester	Foaming Agent
	For lubricating piston and packing systems, resin conveying pumps	BÜFA®-Foaming Resins



Buffing and Polishing

Product name	BÜFA®-BF 50 Buffing Polishing Paste, extra heavy duty	BÜFA®-BF 100 Buffing Polishing Paste, heavy duty	BÜFA®-BF 150 Polishing Paste, extra fine
Art. No.	022-0050	022-0100	022-0150
Characteristics	Buffing and polishing paste, extra strong, without silicone, ammonium and wax, for hand and machine application.	Buffing and polishing paste, medium fine, without silicone, ammonium and wax, for hand and machine application	Polishing paste, extra fine, without silicone, ammonium and wax, for hand and machine application
	BF 50 is a special combination of highly effective abrasive particles. BF 50 removes scratches and buffing marks on polyester and epoxy moulds	BF 100 was developed for a broad spectrum of universal applications. For repair, maintenance and preparation of polyester and epoxy moulds	BF 150 was developed for the 'top finish' on moulds and especially for reworking finished components and fresh PU lacquers. Sprayed mist is finely polished off and paint residue removed



Release Agents, Additives and Ancillaries

Chemlease®-Products: Release agents, Mold Cleaners and Mold Sealers

Product name	Art.-No.	Description
Chemlease® mold cleaners promote efficiency and enhance part quality for composites molders		
Chemlease® Mold-Cleaner EZ	023-0602	Chemlease® Mold-Cleaner EZ is a special blend of HAP free solvents designed to remove wax and contaminants from composite molds. HAPs are not formula constituents of this product.
Chemlease® release agents for addressing a variety of composites molding situations		
Chemlease® 2185	023-2185	Chemlease® 2185 is a unique semi-permanent mold release agent that combines the multiple release capability of a typical semi-permanent product with the application ease of a liquid wax product. 2185 is well suited to the production of high gloss parts from molds that are prepared to a high gloss finish.
Chemlease® 41 EZ	023-0651	Chemlease® 41 EZ is a unique semi-permanent mold release system developed specifically for use where a non-cosmetic finish is required. It is very easy to apply and has both the high heat tolerance and high durability exhibited by typical Chemlease® semi-permanent products.
Chemlease® 41-90 EZ	023-0652	Chemlease® 41-90 EZ is formulated to provide easy release on parts with low draft angles. Chemlease® 41-90 EZ is the high slip version of Chemlease® 41 EZ and is used for the molding of abrasive or low draft parts, often on "B" sides in closed molds.
Chemlease® 75 EZ	023-0653	Chemlease® 75 EZ is a unique semi-permanent mold release designed for use in circumstances where pre-release may be a concern. 75 EZ exhibits all the qualities and characteristics of Chemlease® PMR EZ but is formulated to offer less release ease, should this be needed. It performs well in releasing all commonly-known molding resins, including, but not limited to; polyester, vinyl ester, DCPD, phenolic, epoxy and BMI.
Chemlease® IM02	023-6002	Chemlease® IM02 is an internal release system and lubricant primarily used for non-gel-coated polyester and epoxy resins. When added to polyester resin it reduces the dependency on the external release agent by imparting better flow properties to the polyester resin. Chemlease® IM02 was specifically developed for non-gelcoated parts and the production of UP resins by hot and cold processing, vacuum injection and injection molding. In pultrusion applications, Chemlease® IM02 performs very well as an internal lubricant, offering faster throughput of pultrudate and reduced die wear. Molded parts can generally be painted and bonded without the post cleaning operations usually required when using conventional external release agents.
Chemlease® PMR EZ	023-0655	Chemlease® PMR EZ is a unique semi-permanent mold release agent developed specifically for use on high quality gloss finish molds. It performs well in releasing all commonly-known molding resins, including, but not limited to; polyester, vinyl ester, DCPD, phenolic, epoxy and BMI. PMR EZ is easy to apply and forms an invisible, inert release film on the mold surface that retains or may even slightly enhance the basic high gloss finish of the mold. Chemlease® PMR EZ forms a micro-thin film on the mold surface such that, even with multiple touch-up cycles, the product will not produce any appreciable build-up. The release film is extremely durable and will generate multiple releases, even when molding with the most chemically aggressive resin systems. The release film has very high heat tolerance, known to withstand temperatures in excess of 400 °C (750 °F).
Chemlease® PMR 90 EZ	023-0605	Chemlease® PMR 90 EZ is formulated to provide easy release on parts designed with low draft angles. Chemlease® PMR 90 EZ is the high slip version of the Chemlease® PMR EZ and is used for the molding of abrasive or low draft parts, often on "A" sides in closed mold situations. It performs well in releasing all commonly-known molding resins, including, but not limited to; polyester, vinyl ester, DCPD, phenolic, epoxy and BMI.
Chemlease® MPP 2180	023-0712	Chemlease® MPP 2180 is a solvent-based adhesion promoter and mould sealant that was especially developed to meet requirements for producing wind turbine blades. It is used on plastic moulds. Polyester (gelcoat and non-gelcoat processes), epoxy or phenol resin are also suitable substrates. Chemlease® MPP 2180 is not suitable for sealing moulds with finetextured surfaces or ceramic tools.
Chemlease® 2196 W	023-2196	Chemlease® 2196 W is a semi-permanent, water based release agent for demoulding components made of composite materials. Chemlease® 2196 W is applied to the mould at room temperature. When demoulding, the surface texture of the mould is transferred to the demoulded component. Chemlease® 2196 W improves demouldability, especially for thermoformed parts.
Chemlease® 2203 W	023-0620	Chemlease® 2203 W is a water based, semi-permanent release agent for demoulding parts made of composite materials, including polyurethane, gelcoat and epoxy resin systems. Chemlease® 2203 W can be applied at room temperature or on hot moulds. It does not create high gloss surfaces on parts.
Chemlease® Mold Sealers		
Chemlease® 15 Sealer EZ	023-0650	Chemlease® 15 Sealer EZ is developed to condition and seal mold surfaces, reduce mold porosity and act as a base for new or reconditioned molds. It is compatible with fiberglass, aluminum, steel, and most solid or dense surfaces and is stable at high temperatures. Usage of Chemlease® Sealer 15 EZ reduces overall labor time and costs in mold maintenance and by shortening mold break-in time.



Release Agents, Additives and Ancillaries

BYK-Products



Silicone-free de-airing agents for unsaturated polyester, epoxy and polyurethane systems					
Product name	BYK-A 500	BYK-A 501	BYK-A 515	BYK-A 555	BYK-A 560
Art. No.	053-0500	053-0501	053-0515	053-0555	053-0560
UP resins	✓	(✓)	✓	✓	✓
Fibre wetting			(✓)		✓
Gelcoats	(✓)	(✓)	(✓)	✓	✓
Casting resin	(✓)	(✓)	(✓)	✓	✓
Transparent systems	✓				
Epoxy resins	✓	✓		(✓)	(✓)
PUR systems	(✓)	(✓)	✓	(✓)	
Acrylate systems			✓		

Wetting and dispersing additives to reduce viscosity and to prevent settling of fillers in cold-curing resin systems		
Product name	BYK-W 980	
Art. No.	053-0980	
Unsaturated polyester resins	✓	
Acrylate resins	✓	
Polyurethane resin systems	✓	
Epoxy resins	✓	

Wetting and dispersing additives to reduce viscosity in cold-curing resin systems		
Product name	BYK-W 909	BYK-W 985
Art. No.	053-0909	053-0985
Unsaturated polyester resins	✓	✓
Acrylate resins		
Polyurethane resin systems		✓
Epoxy resins		✓

Wetting and dispersing additives to prevent settling and to stabilise the shade of colour in cold-curing systems		
Product name	BYK-W 909	BYK-W 985
Art. No.	053-0909	053-0985
Unsaturated polyester resins	(✓)	✓
Polyurethane resin systems		
Epoxy resins	(✓)	✓

(✓): Please get in touch with our Technical Service Department

Release Agents, Additives and Ancillaries

BYK-Products



Styrene emission reducers for unsaturated polyester, DCPD and vinyl ester resins		
Product name	BYK-S 740	BYK-S 750
Art. No.	053-0740	053-0750
Orthophthalic acid resin	✓	(✓)
DCPD based resins		✓
Isophthalic acid resins	(✓)	✓
Vinyl ester resins		✓

Rheology additive for vinyl ester and epoxy resins, unsaturated polyester resins and gelcoats		
Product name	BYK-R 605	
Art. No.	053-0605	
Vinyl ester resins	✓	
Unsaturated polyester resins	✓	
Epoxy resins	✓	
Polyurethane resin systems	✓	
Gelcoats	✓	

(✓): Please get in touch with our Technical Service Department



Copyright: BYK-Chemie GmbH



IDEAL STRENGTH

Reinforcements, Core & Non-woven Materials

Composites



Chopped strand mats

Type of mat	Emulsion mat	Powder mat	Powder mat	Powder mat	
Type of glass	E-glass	E-glass	E-glass	ECR-glass	
Fibre [tex]	30	30	15	30	
Type of binder	emulsion, easily soluble	powder, easily soluble	powder, easily soluble	powder, easily soluble	
Weight [g/m²]	300, 450, 600, 900	300, 450, 600, 900	150, 225, 300, 450	300, 450, 600	
Width [cm]	127	127	127	127	



Copyright: Lantor BV

Textile glass complex

Type of complex	450 / 580		
Mat [g/m²]	450		
Woven roving [g/m²]	580		
Width [cm]	127		

Textile glass - woven roving

Type of woven roving	woven roving	woven roving	
Type of glass	E-glass	ECR-glass	
Weight [g/m²]	300, 480, 500, 580, 720, 820	300, 500, 600, 800	
Width [cm]	127	127	

Reinforcements, Core and Non-woven Materials

Low weight, chemically inert and strong mechanical properties in the right orientation are the most important elements when selecting reinforcement materials for demanding applications. Because of its outstanding mechanical properties, glass fibre is the most used reinforcement material.

The production of glass fibres begins in melting furnaces in a direct spinning process. In this process, raw materials traditionally used in the production of glass such as quartz sand, kaolin and limestone modified with special oxides are spun into the finest fibres. These fibres are then bundled into strands of the most various thicknesses and a suitable size is applied.

Glass fibres are then combined with appropriate resins in the form of chopped strand mats, complex, direct and spray rovings, roving mats, continuous filament mats or non-wovens.

Core materials are used to achieve additional strength and rigidity in bonded elements while maintaining low weight. The use of a surface mat reduces disturbances on the surface of your component, improving quality. We can offer you premium products from our partners for any industrial application or when strong mechanical properties, orientation in a certain direction and outstanding working properties are required.

Reinforcements, Core and Non-woven Materials

Continuous filament mat

Type of mat	M8610	M8615	M8643	
Manufacturer	3B	3B	3B	
Application	Infusion	Infusion	Pultrusion	
Resin compatibility	UP, VE und EP	UP, VE und EP	UP, VE und EP	
Rigidity	soft	hard	hard	
Binder	powder	powder	emulsion	
Deformability	good	good	little	
Weight [g/m ²]	225, 300, 450, 600, 900	300, 450, 600, 900	225, 300, 450, 600, 900	
Width [cm]	90, 130, 170	90, 130, 170	90, 130, 170	

Glass fabrics

Type of fabric	Uni-directional	Bi-directional	Biaxial	Triaxial
Fibre	E-glass	E-glass	E-glass	E-glass
Fibre orientation	0°	0°/90°	+45°/-45°	0°/-45°/+45° and -45°/90°/+45°
Weight [g/m ²]	580 - 1210	410 - 860	430 - 1210	600 - 1850
Width [cm]	120 - 130	127 - 130	127	127

Note: Further customer-specific combinations are possible!

Carbon fabric / aramid fabric

Type of fabric	Uni-directional	Biaxial	Biaxial	Biaxial
Fibre	carbon	carbon	carbon	aramid
Fibre orientation	0°	0°/90°	+45°/-45°	+45°/-45°
Weight [g/m ²]	570	650	580 - 1211	450
Width [cm]	127	127	140	127

Note: Further customer-specific combinations are possible!

Reinforcements, Core and Non-woven Materials

Lantor Finishmat® – Surface veil

Product name	D 7760		6691 SL
Art. -No.	052-7760		052-6002
Weight [g/m ²]	60		20
Thickness [mm]	0,50 *		0,3
Resin absorption [g/m ²]	400 *		350
Binder	No binder		Acrylat
Fibre	Polyacryl/nitril		Polyester
Elongation [%]	100 (in length and width direction)		>10
Roll length [m]	100		1000
Width [m]	1.1		1

* special widths on request * depending on process pressure

Product name	6691 LL	
Art. -No.	052-6004	
Weight [g/m ²]	40	
Thickness [mm]	0.45	
Resin absorption [g/m ²]	500	
Binder	Acrylate	
Fibre	Polyester	
Elongation [%]	>10	
Roll length [m]	1000	
Width [m]	1	

Lantor Coremat® – Non-woven material

Product name	Coremat® Xi 1 mm	Coremat® Xi 2 mm	Coremat® Xi 3 mm	Coremat® Xi 4 mm	Coremat® Xi 5 mm	Coremat® XM 2 mm
Art. -No.	052-0301	052-0302	052-0303	052-0304	052-0305	052-5002
Thickness [mm]	1	2	3	4	5	2
Roll length [m]	160	80	50	40	30	80
Roll width [m]	1	1	1	1	1	1
Resin Consumption [kg/m ²]	0.6	1.2	1.8	2.4	3	1
Dry weight [g/m ²]	35	62	88	114	125	96
Density Impregnated [g/cm ³]	0.63	0.63	0.63	0.63	0.63	0.54

Product name	Coremat® XM 3 mm	Coremat® XM 4 mm	Coremat® XM 10 mm
Art. -No.	052-5003	052-5004	052-5000
Thickness [mm]	3	4	10
Roll length [m]	50	40	15
Roll width [m]	1	1	1
Resin Consumption [kg/m ²]	1.5	2	6.5
Dry weight [g/m ²]	128	163	335
Density Impregnated [g/cm ³]	0.54	0.54	0.68



OPTIMAL SAFTY

Fire Retardant systems

Composites

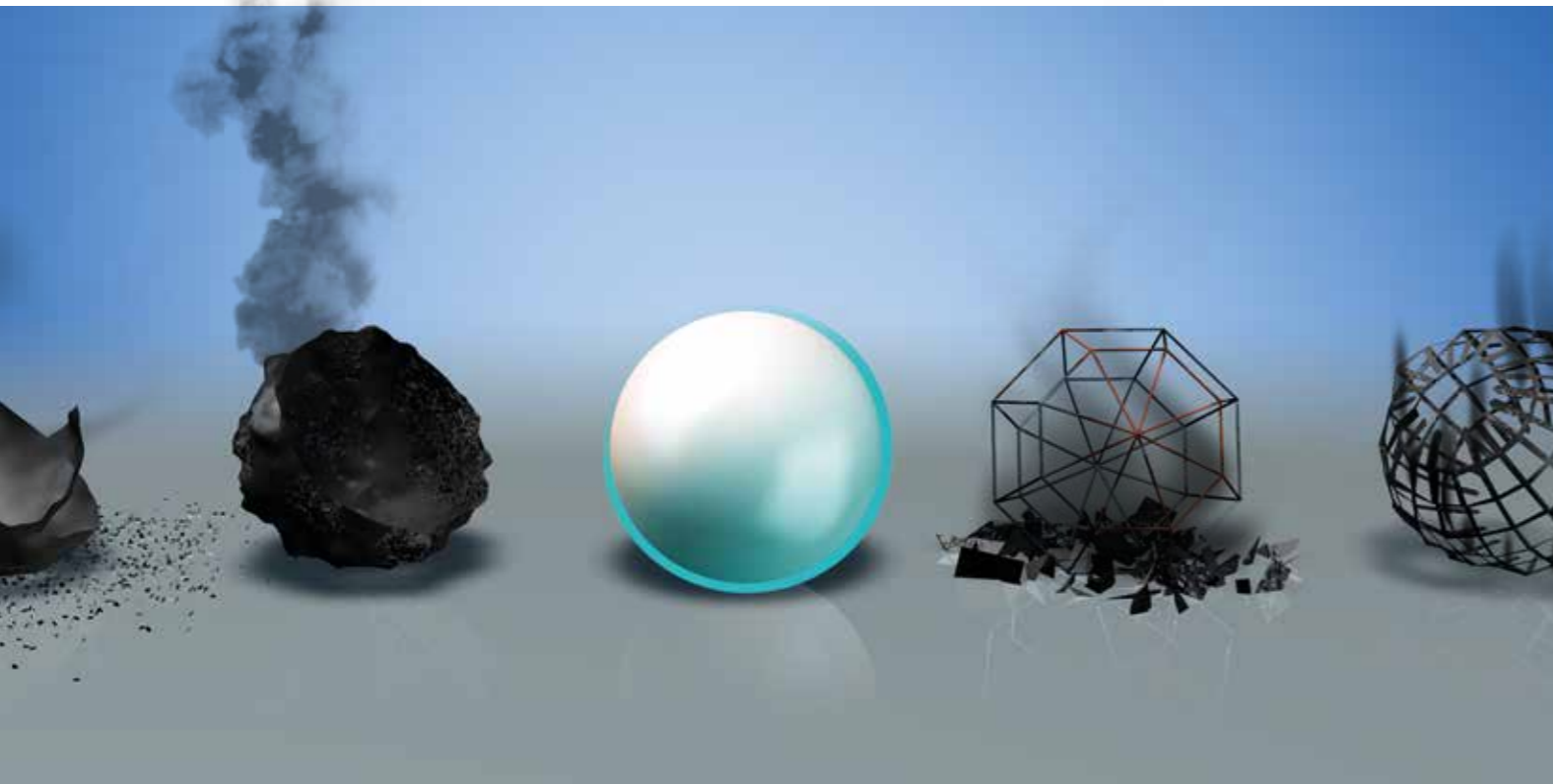

Fire Retardant Systems

BÜFA®-Firestop – Fire protection with a system

In all systems in which glass fibre reinforced plastics are used, BÜFA®-Firestop makes GRP composites a flame retarding material and the GRP cladding turns into a fire protection wall.

Bottom line: BÜFA®-Firestop protects itself. This extraordinary effect is achieved by:

1. Carbonization

When exposed to heat, the integrated flame retardant converts to phosphoric acid. This causes the surface to carbonize which in turn acts as a protective layer.

2. Elimination of water

At temperatures above 200 °C, aluminium hydroxide is split into aluminium oxide and water. The water cools the source of fire and thins the resulting fumes. Aluminium oxide forms a ceramic protective layer.

3. Intumescence

Higher temperatures cause the surface of the component to swell. During the swelling process, the surface sets a carbon based protective foam free.

4. Effect in the gas phase

Through efficient suppression of the source of fire, starting in the gas phase, further spread of the fire is prevented.

The products in the BÜFA®-Firestop line can make optimum use of their qualities, either individually or combined with each other, in all imaginable applications.

All of the BÜFA®-Firestop products are strictly tested according to German as well as international standards. They can be applied quickly without any problems and no special requirements are placed on the production process.

BÜFA Fire Retardant systems give GRP components the necessary protection against fire and therefore give you optimum safety. Innovative solutions for all applications!

Why BÜFA Fire Retardant Systems?

In-house research and development

In-house production

In-house test centre where the following test methods are used:

- ISO 5660 (Cone Calorimeter)
- DIN 5510-2
- LOI (Limited Oxygen Index) ISO 4589-2
- UIC 564-2

The result:
Maximum safety and maximum efficiency at minimum cost.



Cone Calorimeter

Halogenfree resins

Resin name	BÜFA®-Firestop S 425	BÜFA®-Firestop S 430	BÜFA®-Firestop S 520	BÜFA®-Firestop S 555	BÜFA®-Firestop S 570	BÜFA®-Firestop S 900 Foaming Resin
Art. No.	716-0425	716-0430	716-0520	716-0555	716-0570	716-0900
Resin base	DCPD	DCPD	DCPD	DCPD	OP	OP
Non-volatile matter [%]	56	78	74	69	84	70
Viscosity [mPa.s]	230 (20s/1)	720 (20s/1)	800	750	900	1250
Elongation at break [%]	not tested	not tested	2.8	not tested	2	1.8
Tensile strength [MPa]	not tested	not tested	82	not tested	82	58
HDT [°C] calculated	110	110	100	100	88	78
Comments	Slightly filled, halogen-free, pre-accelerated, for structural components in vacuum injection processes	Halogen-free, filled system, HLU, ideal for spray up application, preaccelerated	ATH filled injection resin for structural components, preaccelerated	ATH filled injection resin, preaccelerated	ATH-filled, thixotropic resin for structural components, preaccelerated	Filled foaming resin with good fire retardant properties

Resin name	BÜFA®-Firestop 5001-W-2	BÜFA®-Firestop 5001-T-1	BÜFA®-Firestop 8175-W-1
Art. No.	716-5002	716-5003	716-8175
Resin base	DCPD	DCPD	DCPD
Non-volatile matter [%]	80	not tested	76
Viscosity [mPa.s]	1100 (20s/1)	100	750 (20s/1)
Elongation at break [%]	2.2	0.45 (filled)	3
Tensile strength [MPa]	87	51 (filled)	80
HDT [°C]	90	not tested	> 100
Comments	Highly ATH-filled resin for higher standards, preaccelerated	Prepared to be highly filled, little smoke development (+ 300 parts of ATH), not preaccelerated	ATH-filled, thixotropic resin for structural components, preaccelerated



Halogenated resins

Resin name	BÜFA®-Firestop S 810	BÜFA®-Firestop 2754-P-2	BÜFA®-Firestop 2777-P-1	BÜFA®-Firestop 6806-N-5	BÜFA®-Firestop 6815-N-4	BÜFA®-Firestop S 840
Art. No.	716-0810	716-2754	716-2777	788-0806	788-0816	788-0840
Resin base	DCPD	OP	DCPD	OP	DCPD	ISO
Non-volatile matter [%]	82	65	68	60	65	60
Viscosity [mPa.s]	500 (250s/1)	230 (20s/1)	420 (20s/1)	200	210	not tested
Elongation at break [%]	not tested	1.8	1.2	0.6	1.9	>100
Tensile strength [MPa]	not tested	49	25	96	75	5
HDT [°C]	not tested	65	50	63	54	35
Comments	ATH-filled and halogenated white resin for the highest fire protection requirements, not preaccelerated, also available as a nature version (716-0811)	Halogenated unfilled resin for HLU- and RTM applications, preaccelerated, also available as a filled version (716-2755)	Halogenated unfilled resin for HLU applications, preaccelerated, for IMO 1006 life boats	Halogenated resin for translucent applications, not pre-accelerated	Halogenated resin for translucent applications, designed for higher standards, not pre-accelerated	Halogenated highly flexible resin (e.g. for roofing applications), not preaccelerated, also available as a styrene free version (788-0842)

Fire Retardant Systems



Gelcoats

Gelcoat name	BÜFA®-Firestop GC S 230	BÜFA®-Firestop GC S 250	BÜFA®-Firestop GC S 260	BÜFA®-Firestop GC S 270	BÜFA®-Firestop GC S 285	BÜFA®-Firestop GC S 300
Art. No	714-2300	708-colour (spraying quality) / 728-colour (brushing quality)	714-2600	714-2702	714-2852	714-3000
Resin base	IP	IP	OP / NPG	VE / DCPD	IP	VE / DCPD
Non-volatile matter [%]	82	Colour 708 = 77 Colour 728 = 84	76	84	80	85
Viscosity [mPa.s]	30,000	Colour 708 = 7,500 Colour 728 = 30,000	11,500	28,000	14,000	25,000
Elongation at break [%]	5	8.2	3.4	3	4.5	2.5
Tensile strength [MPa]	50	52	56	45	48	45
HDT [°C]	59	41	39	60	36	85
Comments	Gelcoat in a spraying quality with increased fire protection properties	Gelcoat in a spraying quality with good fire protection properties	Gelcoat in a spraying quality with increased fire protection properties	Gelcoat in a hand and spraying quality with highest fire protection properties	Gelcoat in a hand and spraying quality with highest fire protection properties	Gelcoat in a spraying quality with highest fire protection properties

Chemical properties	DCPD: dicyclopentadiene	OP: orthophthalic acid	IP: isophthalic acid	VE: vinyl ester	NPG: neopentyl glycol
----------------------------	-------------------------	------------------------	----------------------	-----------------	-----------------------

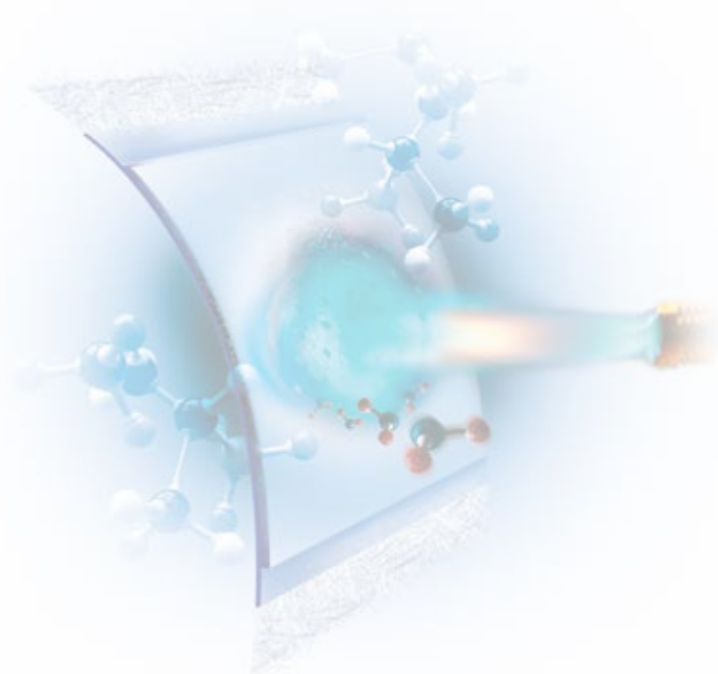

FR-Additives

Product name	BÜFA®-Accelerator Complex 9003	BÜFA®-Accelerator Complex 9004	BÜFA®-Additive Viscoreducer	BÜFA®-Repair Additive	BÜFA®-Accelerator Foaming Agent
Art. No.	715-9003	715-9004	742-0018	742-0030	020-0880
Chemical composition	Accelerator complex for curing of highly filled fire retardant systems	Accelerator complex for curing of highly filled fire retardant systems based on polymeric cobalt	Viscosity reducer for filled HLU- and Infusion systems	Repair solution for the repair of gelcoat surfaces in spray up technics	Foaming agent for BÜFA®-Foaming resins

Fire Retardant Systems



Bonding Pastes and further additives

Product name	BÜFA®-Firestop Liquid mat	BÜFA®-Firestop Adhesive 0255	BÜFA®-Firestop Barriercoat 9002	BÜFA®-Firestop Surfer
Art. No.	715-0245	715-0255	715-0709	715-0250
Resin base	OP	VE	IP	IP
Non-volatile matter [%]	87	85	83	72
Viscosity [mPa.s]	300,000	400,000	29,000	10,000
Elongation at break [%]	2.5	4.5	8	6
Tensile strength [MPa]	6.5	12.5	not tested	not tested
HDT [°C]	70	85	not tested	not tested
Comments	Liquid fire protection mat: Levels sharp edges and corners, fire protection adhesive	Adhesive for structural applications with increased fire protection properties	Fire protection barriercoat to achieve optimum surface quality	Spray spatula with fire retardant properties S

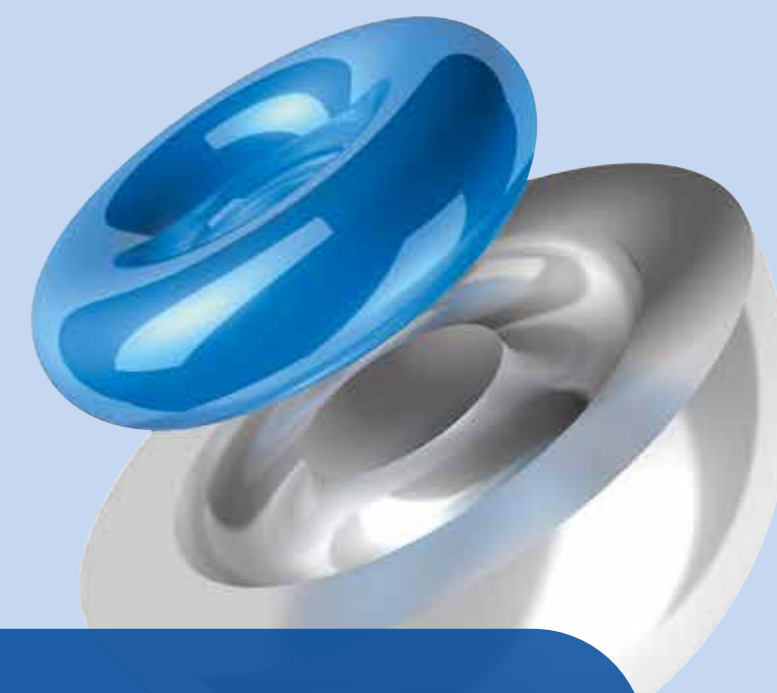

IN GREAT SHAPE

Mould Making Systems

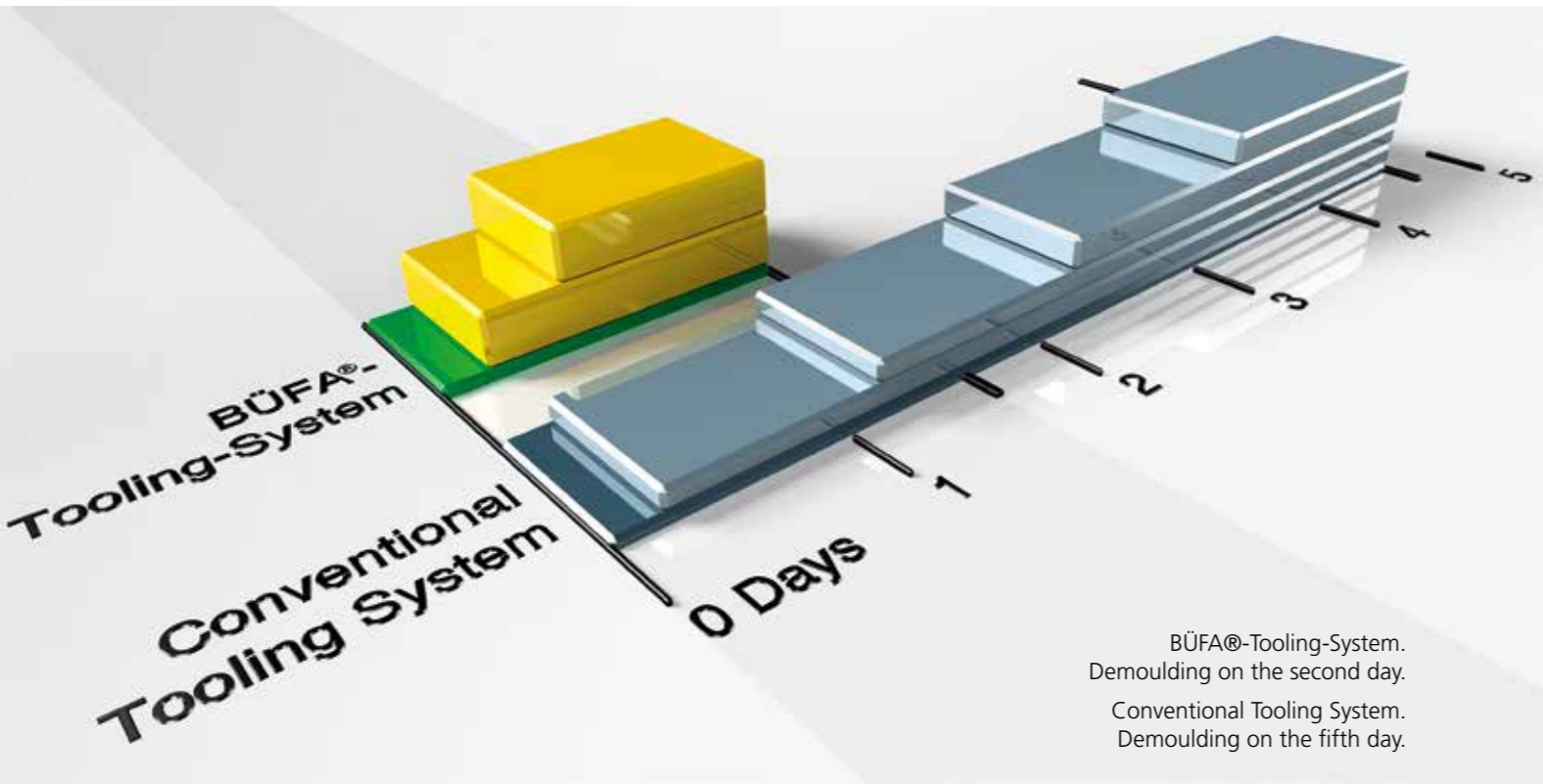

BÜFA®-Tooling-System.
Demoulding on the second day.
Conventional Tooling System.
Demoulding on the fifth day.

Mould Making Systems

BÜFA®-Tooling-Systems

In the GRP industry, only materials with the best product properties are used to produce moulds of the highest quality.

Extreme resistance to styrene and temperature, high mechanical loading capacity, good gloss over the long-term as well as dimensional accuracy are important decision criteria when selecting a reliable tooling system

The Material

Thanks to new developments in materials, our new BÜFA®-VE-Tooling-Gelcoats fulfil these decisive criteria. By combining them with the new, low-styrene, fast curing and practically shrink-free BÜFA®-Tooling-Resin, moulds that are technically of the highest quality, can be produced in just one day instead of a week.

BÜFA®-Tooling-Resin/Art. No. 700-1974

- pre-accelerated
- standard MEKP cure for simplicity and cost efficiency
- rapid cure for fast mould making
- peroxide indicator – colour change mechanism
- low in styrene – practically no shrinkage
- non-tacky surface
- low density (1,35 g/cm³) - means lighter moulds

BÜFA®-VE-Tooling-Gelcoat/ Art. No. 720-1000 bzw. 720-2000

- pre-accelerated
- MEKP curable without gassing
- good throughcure
- easy application
- scratch resistant, high gloss surfaces
- extreme resistance towards styrene and heat

BÜFA®-VE-Tooling-Gelcoats

Product name	BÜFA®-Conductive-Tooling GC-S natur	BÜFA®-VE-Tooling-Gelcoat-S nature	BÜFA®-VE-Tooling-Gelcoat-H nature
Art. No.	720-0100 (nature)	720-1000	720-2000
Application	spraying quality	spraying quality	brushing quality
Resin base	Hybrid	BPA/VEU	BPA/VEU
Pigmentation	520-0101 (black) / 520-0102 (green)	nature	nature
Viscosity [mPa.s] – Spindle/rpm	24,000 - 4/4	33,000 -4/2	53,000 -4/2
Styrene content [%]	49	40	40
Peroxide / accelerator	2 % MEKP moderately reactive, pre-accelerated	2 % MEKP moderately reactive, pre-accelerated	2 % MEKP moderately reactive, pre-accelerated
Gel time [min]	15	14	14
Tmax [°C]	195	185	185
Elongation at break [%]	> 3	> 3	> 3
HDT [°C]	120	130	110
Range of use / comments	Conductive properties [10 ⁶ Ω], thixotropic mould making gelcoat, good gloss performance	GRP mould-making, available in 4 shades of colour and a non-tinted version, not weather resistant	GRP mould-making, available in 4 shades of colour and a non-tinted version, not weather resistant



Recommended workshop temperature optimal between 18 – 24 °C

To achieve the greatest contrast to the moulded part, black is the optimal colour for white products. Green is the optimal colour for white products with dark blue stripes. Orange is the commonly used colour for light blue products. Grey is the last colour to complete the series of tooling gelcoats.

Available Gelcoat Colours

Colour	Art. No. spraying quality	Art. No. brushing quality
Black	520-1104	520-2107
Light Green	520-1108	520-2109
Orange	520-1110	520-2111
Grey	520-1112	520-2113
Nature	720-1000	720-2000

Mould Making Systems



Our recommended standard solutions

BÜFA®-Tooling System up to 80 °C with normal loads	BÜFA®-Tooling System up to 80 °C for heavier loads	BÜFA®-Tooling System up to 120 °C
BÜFA®-VE-Tooling-Gelcoat spraying or brushing quality	BÜFA®-VE-Tooling-Gelcoat spraying or brushing quality	BÜFA®-VE-Tooling-Gelcoat spraying or brushing quality
1 layer 150 g/m ² powder-bonded glass fibre mat with 6 layers 300 g/m ² power-bound, glass fibre mat wet-on-wet with BÜFA®-Resin UP 1974 Tooling	1 layer 150 g/m ² mit 225 g/m ² power-bound, glass fibre mat with Atlac 580 ACT	1 layer 225 g/m ² power-bound, glass fibre mat with BÜFA®-Resin VEU 1978 HLU
followed intermediate curing	followed by 24 hours intermediate curing	followed by 24 hours intermediate curing
4 layers 450 g/m ² power-bound, glass fibre mat wet-on-wet with BÜFA®-Resin UP 1974 Tooling	6 layers 300 g/m ² power-bound, glass fibre mat wet-on-wet with BÜFA®-Resin UP 1974 Tooling	max. 2 layers 225 g/m ² power-bound, glass fibre mat with BÜFA®-Resin VEU 1978 HLU
	followed intermediate curing	followed intermediate curing
	4 layers 450 g/m ² power-bound, glass fibre mat wet-on-wet with BÜFA®-Resin UP 1974 Tooling	max. 2 layers 225 g/m ² power-bound, glass fibre mat with BÜFA®-Resin VEU 1978 HLU

Mould making resins

Product name	BÜFA®-Resin UP 1974 Tooling	Atlac 580 ACT	BÜFA®-Resin VEU 1978 Tooling
Art. No.	700-1974	780-5800	700-1978
Application	hand lay-up and spray-up	hand lay-up	hand lay-up
Resin base	DCPD	BPA/VEU	BPA/VEU
Viscosity [mPa.s] – Spindle/rpm	1,150 -3/20	1,300	1,500 -3/20
Styrene content [%]	35	49	41
Peroxide / accelerator	2.0 % MEKP medium reactive, pre-accelerated	2.0 % MEKP medium reactive, pre-accelerated	2.0 % MEKP medium reactive + 0.5 % 742-0070, not pre-accelerated
Gel time [min]	42	30	32
Tmax [°C]	120	140	185
Tensile strength [MPa]	47	83	90
Tensile E-modulus [MPa]	5.6	3.5	3.5
Elongation at break [%]	1.8	4.2	3-4
HDT [°C]	80	115	145
Range of use / comments	GRP tooling. Practically shrink-free laminating resin with an LP additive	GRP tooling. Laminating resin for the first layer of glass	GRP tooling. Laminating resin for high temperature moulds up to 130 °C, construction of max. 2 layers of glass in one working operation

Mould Making Systems



Auxiliary Agents

Product name	BÜFA®-Release Lacquer Nature	BÜFA®-Release Paste	BÜFA®-Release Wax Liquid	BÜFA®-Modelling Compound
Art. No.	741-0052	741-0054	741-0063	740-0004
Characteristics	Polyvinyl alcohol-based dissolved in ethanol/water	Based on synthetic wax and white spirit	Polyethylene wax dissolved in white spirit	Natural wax composition with fillers
	Mould release agent for use on plastic moulds, glossy after drying, tough PVA layer	For use on moulds made of plastic, wood, gypsum, etc., usually used with BÜFA®-Release Lacquer Nature	For use on complicated moulds made of plastic, wood, gypsum, etc., also often used with BÜFA®-Re- lease Lacquer Nature	Permanently plastic modelling compound used in model and mould-making for filling hollow covers, closing voids and for modelling



This legend refers to the values of the tooling system category

Resin base	Reactivity	Viscosity	Accelerator	Mechanical values
VE - vinyl ester DCPD - dicyclopentadiene BPA - bisphenol A VEU - vinyl ester urethane	Reactivity values are orientation values measured on 100 g sample at 20 °C Gel time: Time from 20 °C to 30 °C (mean value) Tmax: Maximum temperature of the 100 g sample (mean value)	Mean value measures with Brookfield DV II at 20 °C Further values: e.g. measured with spindle 4 at 4 rpm (4/4)	742-00070 BÜFA®-Accelerator Complex 0070	Measured on cured, pure resin samples, conditioned according to the information given in the Technical Information Sheet Tensile strength according to ISO 527/2 Tensile E-modulus according to ISO 527/2 Elongation at break according to ISO 527/2 Heat distortion temperature according to ISO 75-A



EFFICIENT MACHINE TECHNOLOGY

Machine Technology, Tools & Ancillaries

Composites



BÜFA®-Tec GSU ES1 EM Product number 028-0182

The ideal gelcoat spraying unit for smaller to medium sized components approx. 1-3 m² (directly out of the container).

Facts

- Clearly arranged machine, easy to operate
- Proved century gun technology
 - Soft, low emission spray fan for best gelcoat air release
 - External mixing: excellent mixing of peroxide (the resin and peroxide are mixed outside)
 - No need to rinse after application

Technical data	
Output rate max., water [l/min]	1.6
Volume of flow per double stroke [ml]	27
Pressure ratio	33:1
Air pressure, entrance [bar]	6
Air consumption, approx. [l/min]	130-200
Length of hose [m]	7.5
Peroxide tank [l]	10
Weight [kg]	30
Dimensions approx. (L/W/H) [mm]	650 x 450 x 820

Machine Technology, Tools and Ancillaries

BÜFA Tec - Efficient Machine Technology

High performance system engineering from planning to "service on demand"

The BÜFA Tec team designs and produces state-of-the-art, robust and very operator-friendly machines and equipment.

They range from hand metering pumps that have proved themselves thousands of times all the way to complex metering and mixing equipment for the most various types of applications.

They also develop very individual solutions for specialised applications in close cooperation with customers. In this case approved modular system is used that allows the resin pump to be controlled pneumatically.

Individually coordinated metering pumps make work highly efficient. Your machines and equipment are coordinated to your requirements – with the entire know-how of the BÜFA Tec Development Department.

BÜFA Tec gelcoat units and fibre spray systems are equipped with extremely stable, generously dimensioned pump units to ensure quiet operation and uniform application. For us, service is another word for comprehensive support. Training on site when new machines and equipment have been added, quick supply of spare parts, a no hassle repair service and extensive advice – that's what the competence of our BÜFA Tec employees stands for – and has for many years all over the world.

Tell us your goals and we will create the prerequisites for profitable, reliable and future-oriented production.

BÜFA Tec – Efficient Machine Technology

- Gelcoat units
- Fibre spray units
- RTM units
- Bonding paste units
- Laminating roll units
- Metering devices
- Distillation units
- Stirring and mixing equipment
- Vacuum consumables
- Tools and Ancillaries
- Solutions for special systems engineering
- Service, maintenance, repair and project consulting
- Spare parts



Variants:

028-0184 BÜFA®-Tec ES1 EM Multicolor

028-0205 Extension pump unit ES 1

Gelcoat Units



BÜFA®-Tec GSU ES1 „Easy Lift“ Product number 028-0352

The ideal gelcoat spraying unit for smaller to medium sized components approx. 1-3 m² (directly out of the container).

Facts

- Clearly arranged machine
- Easy to operate with innovative lift technology
- Proved century gun technology
 - Soft, low emission spray fan for best gelcoat air release
 - External mixing: excellent mixing of peroxide (the resin and peroxide are mixed outside)
 - No need to rinse after application
- With carrier for peroxide container
- High mobility of unit

Technical data	
Output rate max., water [l/min]	1.6
Volume of flow per double stroke [ml]	27
Pressure ratio	32:1
Air pressure, entrance [bar]	6
Air consumption, approx. [l/min]	130-200
Length of hose [m]	10
Peroxide tank [l]	10
Weight [kg]	61
Dimensions approx. (L/W/H) [mm]	880 x 740 x 1550



Gelcoat Units



BÜFA®-Tec GSU Delta5.5 EM Product number 028-1701

Approved application technology for your production processes. Gelcoat application directly out of the container, for smaller to large sized components.

Facts

- Clearly arranged machine, easy to operate
- Innovative pump technology for resin and peroxide with outstanding mixing of the peroxide
- Reliable and durable pump unit with high output even in demanding production environments
- Clear reduction of costs since the resin is efficiently transferred to the surface of the mould (also with low air and liquid pressure)
- Century gun technology
 - Low emission and overspray
 - External mixing: excellent mixing of peroxide (the resin and peroxide are mixed outside)

Technical data	
Output rate at 30 cycles/min, water [l/min]	3.8
Volume of flow per double stroke [ml]	126
Pressure ratio	17:1
Air pressure, entrance [bar]	6
Air consumption, approx. [l/min]	200-500
Length of hose [m]	10
Weight [kg]	60
Dimensions approx. (L/W/H) [mm]	1100 x 550 x 1500

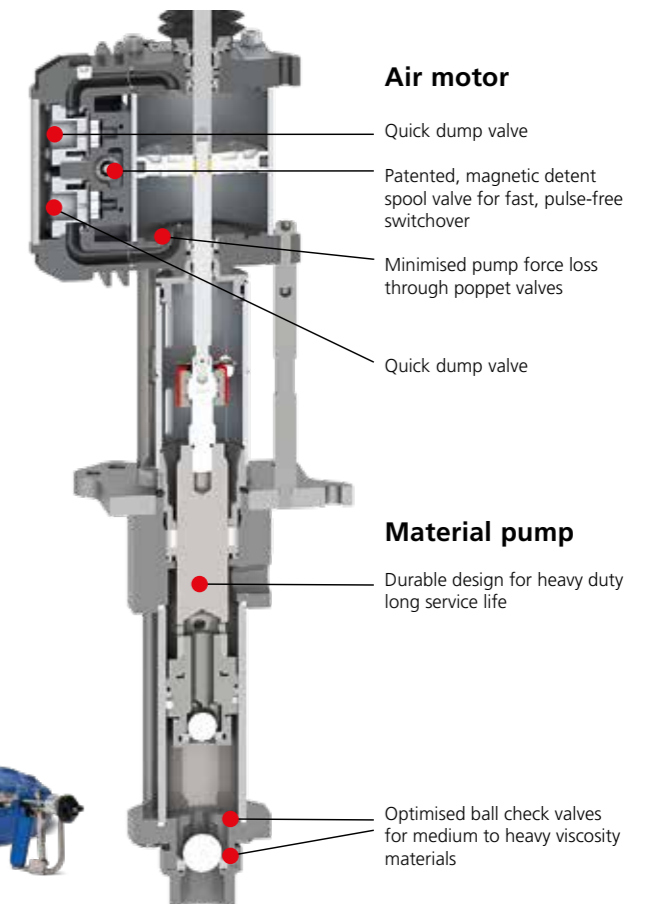

Accessories:

028-2600 Flow heater set 3 kW, ATEX

Innovative Delta pump technology

Systems engineered for a long and reliable service life, made from modular sub-assemblies for fast re-builds and easy maintenance.

Individual configuration of the machine is possible through the use of accessories, e.g. flow heater or peroxide flow sensors.

Gelcoat Units



BÜFA®-Tec Spray gun Polycon Product number 026-0300

Greatest possible flexibility through nine nozzle sizes and two container sizes, making it suitable for practically all types of gelcoats with the most different viscosities.

Facts

- Quick colour change
- Low cost
- Easy to use
- Easy to clean and maintain
- Fast, uniform coating

Accessories:

-  029-0705
-  029-1098
-  **Polycon nozzle set (9 nozzles)**
Product No. 026-0301

Nozzle (single)		
Diameter [mm]	Polycon nozzle	Art. No.
0.8	Nr. 1	026-0341
1.6	Nr. 2	026-0342
2.4	Nr. 3	026-0343
3.2	Nr. 4	026-0344
4.0	Nr. 5	026-0345
4.8	Nr. 6	026-0346
5.6	Nr. 7	026-0347
6.4	Nr. 8	026-0348
7.2	Nr. 9	026-0349

Container	
Container size [l]	Art. No.
1.0	026-0324
2.5	026-0326

Lid for container (l)	
Container size [l]	Art. No.
1.0	026-0327
2.5	026-0325

Bow	
Container size [l]	Art. No.
1.0	026-0310
2.5	026-0330

Technical data	
Material	Aluminium
Output rate max., water [l/min]	3.5
Air pressure, entrance [bar]	3.5-7.0
Air consumption, approx. [l/min]	400-800
Weight [kg]	0.5
Air connection	Single hand coupler NW 7 (filtered air)

Nozzle and pressure selection

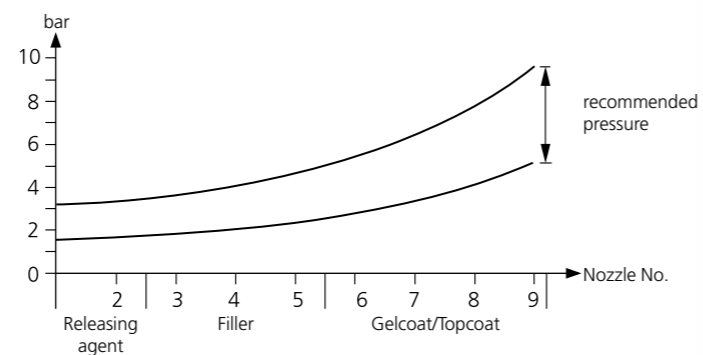

Fibre Spray Units



BÜFA®-Tec FSU Delta5.5 EM Product number 028-1750

Effective fibre spraying unit for practically all components and resin systems.

Facts

- Easy to operate
- Innovative pump technology for resin and peroxide
- Proved century gun technology
 - Soft, low emission spray fan
 - External mixing: excellent mixing of peroxide (the resin and peroxide are mixed outside)
- High performance BINKS Cutter, also with internal mixing gun

Technical data	
Output rate at 30 cycles/min, water [l/min]	3.8
Volume of flow per double stroke [ml]	126
Pressure ratio	17:1
Air pressure, entrance [bar]	8
Air consumption, approx. [l/min]	400-900
Length of hose [m]	7.5
Weight [kg]	100
Dimensions approx. (L/W/H) [mm]	1000 x 800 x 2600
Boom from centre ca. [mm]	3600



Accessories:

- 028-2600 Flow heater Set 3 kW, ATEX
- 028-0956 Peroxide flow sensor, electronic



Information on the air motor and the material pump is found on page 117.
Innovative Delta Pump Technology same as 028-1701 GSU Delta.

RTM Units



BÜFA®-Tec Delta3.3 RTM Product number 028-4469

RTM unit on a Delta base, for small to large-sized components.

Facts

- Innovative pump technology for resin and peroxide
- Mechanically driven peroxide pump
- Internal mixing at the injection head.
- Recirculation of components
- Less solvent consumption

Technical data	
Output rate at 30 cycles/min, water [l/min]	3.8
Volume of flow per double stroke [ml]	126
Pressure ratio	6.5:1
Air pressure, entrance [bar]	6
Air consumption, approx. [l/min]	100-200
Length of hose [m]	7.5
Weight [kg]	75
Dimensions approx. (L/W/H) [mm]	1000 x 800 x 2200
Boom from centre ca. [mm]	1800

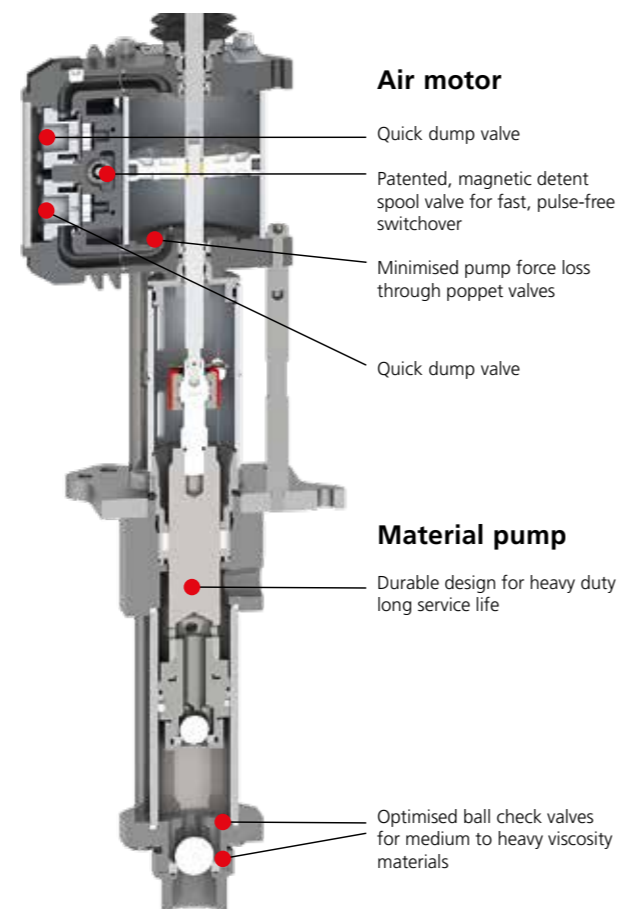

Accessories:
028-0971 BÜFA®-Tronic RTM-Pressure control, electronic
028-2600 Flowheater set 3 KW, ATEX

Bonding Paste Units



BÜFA®-Tec BPU Gamma4 Product number 028-1130

This unit was especially designed for processing bonding pastes from small containers (25 l hoblocks) and is especially suitable for the application of products without fibres or hollow spheres.

Facts

- Compact system
- 2-component mixing head with flushing function
- The bonding paste can be taken directly from the container
- Follower plate that reduces leftovers
- Peroxide pump with spindle mechanism and with infinitely variable adjustment of the peroxide content
- Less solvent consumption

Technical data	
Output rate at 30 cycles/min, water [l/min]	4.6
Volume of flow per double stroke [ml]	78
Pressure ratio	25:1
Air pressure, entrance [bar]	6
Air consumption, approx. [l/min]	250-400
Length of hose [m]	10
Flushing agent tank [l]	10
Weight [kg]	211
Dimensions approx. (L/W/H) [mm]	1000 x 860 x 1500



Bonding Paste Units



BÜFA®-Tec BPU Theta11 Product number 028-1102

The Theta11 Bonding Paste Unit offers all the advantages of this series for daily bonding of components. Ideal for large components where reproducible component qualities and efficient use of bonding paste is required.

Facts

- Large pump unit
- Guaranteed high output with smooth, wear resistant pump operation
- The bonding paste can be taken directly from the drum
- Follower plate that reduces leftovers
- Peroxide pump with spindle mechanism and infinitely variable adjustment of the peroxide content
- Less solvent consumption

Technical data	
Output rate at 20 cycles/min, water [l/min]	10.5
Volume of flow per double stroke [ml]	521
Pressure ratio	32:1
Air pressure, entrance [bar]	6
Air consumption, approx. [l/min]	800-1200
Length of hose [m]	15
Flushing agent tank [l]	19.5
Weight [kg]	350
Dimensions approx. (L/W/H) [mm]	1850 x 700 x 2600



Bonding Paste Units



Excellent results are achieved when working with the following BÜFA bonding pastes for high strength bonding as well as structural bonding:

Art. No.	Product name	Viscosity [mPa.s]	Colour	Gel time [min]	Curing time [min]	Peroxide indicator	Marine					Rail vehicles	Automotive		Other		
							Repair	Deck + hull	Interior walls	Sandwich constructions	Inliner + hull	Deck + inside roof lining	Levelling	Sandwich constructions	Structural bonding	Sandwich constructions	Structural bonding
740-0110	BÜFA®-Bonding Paste 0110	1,800,000	opaque/natural	60 at 25 °C	85		✓	✓	✓	✓		✓	✓	✓	✓	✓	✓
740-0114	BÜFA®-Bonding Paste 0114	1,800,000	opaque/natural	35	60		✓	✓	✓	✓		✓	✓	✓	✓	✓	✓
740-0125	BÜFA®-Bonding Paste 0125	225,000	blue	23	50	✓		✓		✓			✓				
740-0250	BÜFA®-Bonding Paste 0250	1,000,000	blue	20	37			✓					✓				
740-0601	BÜFA®-Bonding Paste 0601	1,100,000	blue	25	50	✓		✓							✓		
740-0002	BÜFA®-Fine Body Filler Spray	23,000	grey	8	16	✓										✓	
740-0410	BÜFA®-Bonding Paste 0410	500,000	natural	24	42												✓

The recommendations presented above are a few of the possibilities for using bonding pastes. For more detailed information, please get in touch with our Technical Service Department. We'll be glad to help.

Abbreviations for base resins: VE – vinyl ester, OP – orthophthalic acid, IP – isophthalic acid, THP – tetrahydrophthalic acid, NPG – neopentyl glycol, BPA – bisphenol A
(✓)=Please get in touch with our Technical Service Department.



Laminating Roll Units

BÜFA®-Tec Laminating Roll Units

Robust, very reliable laminating roll units that can be used for medium and large-sized components.

UNI 125
Product number 028-1250

UNI 250
Product number 028-1275

Facts

- Robust and proven pump technology
- Self-adjusting resin pump gaskets
- Process reliability through built-in gel time control signal
- Optimised resin consumption - stroke counter for the prescribed resin flow rate
- Safety device against insufficient hardener
- Minimal solvent consumption - Pulse flushing



Technical data		
	UNI 125	UNI 250
Output rate at 30 cycles/min, water [l/min]	3	6
Pressure ratio	17:1	9:1
Air pressure, entrance [bar]	6	6
Air consumption, approx. [l/min]	200-700	200-700
Percentage of peroxide [%]	1-5	1-2.5
Warning device: a) flexible time signal b) preselected counter	up to 99999 min. up to 99999 (double stroke lift)	up to 99999 min. up to 99999 (double stroke lift)
Flushing agent tank [l]	19.5	19.5
Flushing agent consumption (l / flushing operation)	< 1	< 1
Weight [kg]	90	90
Dimensions approx. (L/W/H) [mm]	1000 x 740 x 1780	1000 x 740 x 1780

With the corresponding tools, the UNI 125/250 can be used as an injection, gelcoat or impregnation facility – even as a fibre spray and fan jet facility if necessary.

Laminating roll with extension pipe:

- 18 x 100 cm
Art. No. 028-0092
- 18 x 140 cm
with pneumatic remote control
Art. No. 028-0094
- 12 x 45 cm
Art. No. 028-0039
- 18 x 25 cm
Art. No. 028-0193



Illustration similar

UNI Gelcoat spraying unit

with gun Airless
Art. No. 029-5387



UNI Injection unit

with injection head
Art. No. 028-0031

Metering Devices

BÜFA®-Tec Polybar

Product number 028-1000
Product number 028-1001 (with stroke counter)

Established 2 component metering for quick, easy and reproducible metering results without scale. The resin is conveyed by a double action, wear-free Teflon bellows pump (DBGM).

Facts

- No leakage of resin through worn out seals
- Infinitely variable pumping capacity
- Exact and repetitious dosing of resin and accelerator, the resin and hardener pumps are automatically pneumatically coupled
- Hardener is metered by adjustable hardener pump lift
- No loss of material
- No weighing and re-filling
- Increased safety and cleanliness at the workplace
- Robust design

Technical data	
Output rate at 30 cycles/min, water [l/min]	3
Volume of flow per double stroke [ml]	100
Pressure ratio	1:1
Adjustment range peroxide [%]	1.0-5.0
Air pressure, entrance [bar]	6
Air consumption, approx. [l/min]	100-300
Weight [kg]	30
Dimensions approx. (L/W/H) [mm]	720 x 390 x 580

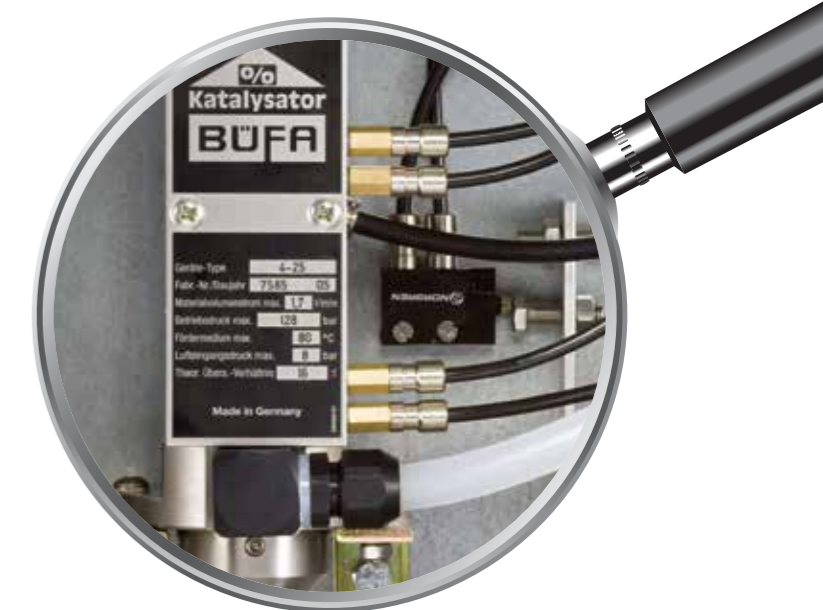

Hand Metering Pumps



Product name	BÜFA®-Tec HDP 30 ml PVDF	BÜFA®-Tec HDP 100 ml PVDF	BÜFA®-Tec HDP 100 ml NV-PP	BÜFA®-Tec HDP 100 ml HV-PP	BÜFA®-Tec HDP 250 ml HV-Al	BÜFA®-Tec HDP 500 ml PP
Art. No.	026-3000	026-0900	026-0600	026-0800	026-0250	026-0500
Piston stroke	30 ml	100 ml	100 ml	100 ml	250 ml	500 ml
Scale graduation	0.5 ml	1 ml	1 ml	1 ml	5 ml	10 ml
Viscosities	For low viscosity liquids, resistant to practically all mediums. Developed for metering organic peroxides.	For low viscosity liquids, resistant to practically all mediums. Developed for metering organic peroxides.	For low viscosity liquids. Developed for metering organic peroxides. Only conditionally solvent resistant.	As Art. No. 026-0600 but with a larger intake and release valves for the conveyance of liquids with higher viscosities up to 2500 mPas.	Suitable for liquids with a higher viscosity of up to approx. 2500 mPas.	Suitable for liquids with a viscosity of up to approx. 2500 mPas, e.g. resins, varnishes, under certain conditons acids.
Valves	With O-ring seal	With ball seal	With ball seal	With ball seal	With ball seal	With ball seal
Materials	PVDF, PTFE, FFKM, stainless steel, glass	PVDF, PTFE, stainless steel, glass	PP, PVDF, stainless steel, glass	PP, PVDF, stainless steel, glass	Anodized aluminium, PTFE, stainless steel, glass	Anodized aluminium, PP, PTFE, stainless steel, glass
Product illustration						
UP resin				✓	✓	✓
EP resin				✓	✓	✓
Gelcoats				✓	✓	✓
Pigment pastes				✓	✓	
Peroxides	✓	✓	✓			
Inhibitors	✓	✓			✓	
Accelerators	✓	✓			✓	
Acetone	✓	✓			✓	
Styrene	✓	✓			✓	

Hand Metering Pumps





Product name	BÜFA®-Tec HDP 500 ml Al	BÜFA®-Tec HDP 1000 ml PP	BÜFA®-Tec HDP 1000 ml Al	BÜFA®-Tec HDP 2-Component Hand Metering Pump	BÜFA®-Tec HDP 2-Component Hand Metering Pump	BÜFA®-Tec HDP 2-Component Hand Metering Pump
Art. No.	026-0550	026-1000	026-1100	026-4711	026-4730	026-4740
Piston stroke	500 ml	1000 ml	1000 ml	100 ml and 10-30 ml adjustable for peroxide	500 ml and 80-160 ml adjustable for the hardener	500 ml and 5-15 ml adjustable for the peroxide
Scale graduation	10 ml	10 ml	10 ml	10 ml	10 ml	10 ml
Viscosities	Corresponds to the 250 ml aluminium pump but with larger volumetric delivery.	Suitable for liquids with a viscosity of up to approx. 2500 mPas, e. g. resins, varnishes, etc..The stroke is executed by a rack and gear drive.	Suitable for liquids with a viscosity of up to approx. 2500 mPas, e. g. resins, varnishes, etc..The stroke is executed by a rack and gear drive.	For UP resins up to approx. 2500 mPas. This pump consists of two coupled piston pumps.	For EP resins up to approx. 2500 mPas. This pump consists of two coupled piston pumps.	For UP resins up to approx. 2500 mPas. This pump consists of two coupled piston pumps.
Valves	With ball seal	With ball seal	With ball seal	Peroxide pump with O-ring seal. Resin pump with ball seal.	Hardener pump with O-ring seal. Resin pump with ball seal.	Peroxide pump with O-ring seal. Resin pump with ball seal.
Materials	Anodized aluminium, PTFE, stainless steel, glass	Anodized aluminium, PP, PTFE, stainless steel, glass	Anodized aluminium, PTFE, stainless steel, glass	Peroxide pump: glass, stainless steel, PVDF, PTFE, FFKM Resin pump: glass, anodized aluminium, PTFE, stainless steel	Hardener pump: glass, stainless steel, PVDF, PTFE, FFKM Resin pump: glass, anodized aluminium, PTFE, stainless steel	Peroxide pump: glass, stainless steel, PVDF, PTFE, FFKM Resin pump: glass, anodized aluminium, PTFE, stainless steel
Product illustration						
UP resin	✓	✓	✓	✓		✓
EP resin	✓	✓	✓		✓	
Gelcoats	✓	✓	✓			
Pigment pastes						
Peroxides				✓		✓
Inhibitors	✓		✓			
Accelerators	✓		✓			
Acetone	✓		✓			
Styrene	✓		✓			

Distillation Units



Product name	ISIDest® Distillation Unit LD 20 EX-E	ISIDest® Distillation Unit LD 30 EX-E
		
Art. No.	029-1615	029-2630
Tank filling quantity [l]	15-20	25-30
Electric output	1.33 KW / 230 V	1.66 KW / 230 V
Recovery / hour [l]	ca. 5.0	ca. 7.0
Working temperature [°C]	max. 200	max. 200
Boiling range [°C]	50-160	50-160
Dimensions (L/W/H) [mm]	940 x 505 x 1210	940 x 505 x 1210
Weight [kg]	70	85
Identification	Ex II 3 G IIB T2	Ex II 3 G IIB T2
Comment	Ideal unit for operations with up to 300 litres of solvent a month, including 50 high temperature resistant plastic bags	Ideal unit for operations with up to 500 litres of solvent a month, including 50 high temperature resistant plastic bags
Accessories	Art. No. 029-1716 Plastic bag LD 20	Art. No. 029-2730 Plastic bags LD 30

Product name	ISIDest® Distillation Unit LD 60 EX-E	ISIDest® Distillation Unit LD 120 EX-E
		
Art. No.	029-1660	029-2953
Tank filling quantity [l]	50-60	100-120
Electric output	4.00 KW / 400 V / 3 ph	6.00 KW / 400 V / 3 ph
Recovery / hour [l]	max. 17.0	max. 21.0
Working temperature [°C]	max. 200	max. 200
Boiling range [°C]	50-160	50-160
Dimensions (L/W/H) [mm]	1170 x 700 x 1240	1630 x 680 x 1380
Weight [kg]	120	180
Identification	Ex II 3 G IIB T2	Ex II 3 G IIB T2
Comment	Ideal unit for operations with up to 1000 litres of solvent a month, including 50 high temperature resistant plastic bags	Ideal unit for operations with up to 2000 litres of solvent a month, including 50 high temperature resistant plastic bags
Accessories	Art. No. 029-2740 Plastic bags LD 60	Art. No. 029-2399 Plastic bags LD 120

Operation of the Distillation Units

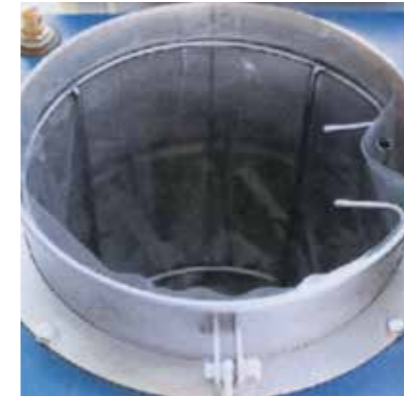

Function:

- The stainless steel container is lined with a plastic bag.
- The soiled solvent is filled into the plastic bag.
- The lid on the stainless steel container is closed.
- The recovery cycle is started.
- The cleaned solvent is collected in a container.
- After the cycle has been concluded, the lid of the stainless steel container is opened.
- The plastic bag along with the residue inside are taken out of the stainless steel container and brought to an appropriate recycling facility in accordance with the valid notes on disposal for the product.
- The stainless steel container remains clean.
- The distillation unit is ready for the next recovery cycle.

Operation:

It's so easy. Just start the recovery cycle – everything else runs automatically.

Safety „Made in Germany“

Internal safety thermostats control the temperature and the recovery cycle – and not just once but twice.

Short-term amortization:

A low purchase price and low operating costs guarantee an amortisation period of 12 months when utilised to full capacity.

Exemplary guarantee:

A 12 month warranty on the distillation unit.

Not covered: Wearing parts and materials used.

Features:

- Components that come in contact with product are made of stainless steel
- Stainless steel condenser, indirectly heated with thermal oil
- Condenser air-cooled
- PTFE lid seal
- Including 50 plastic bags
-  Ex II 3 G IIB T2



No steam pipe in the boiling tank



PTFE lid seal



Air cooled, stainless steel condenser



Integrated vapour temperature display



Safety valve in the container lid



Stable lid clamping bracket



Connection hose for filling drums



Clear oil level control



Welded plastic bag with clip for extreme loads and all solvents



Exchangeable boiling tank

Formula A	Amortisation calculation for distillation units
$A = \frac{K}{B \times (0.8 \times C - 0.05 + E)}$	Units
	A = Amortisation period (months)
	K = Purchase price (Euro)
	B = Disposal quantity per month (litre) according to disposal receipts
	C = Disposal costs per litre (Euro) according to disposal invoices
	E = Price of fresh solvent (Euro) per litre
	*** A leftover disposal of 20 % after distillation and energy costs of 5 cents per litre were taken into account in the formula.

Stirring and Mixing Equipment



Stirring unit for IBC containers	Stirring unit for IBC containers	Stirring unit for IBC containers	Stirring unit for open containers	Stirring unit for IBC containers	Stirring unit for IBC containers „Disc“
Art. No. 028-0145	Art. No. 028-0144	Art. No. 028-0147	Art. No. 028-0143	Art. No. 028-0173	Art. No. 029-5431
<ul style="list-style-type: none"> - Hand-held unit with a stable grip - Fast mixing without stirring in air - (Not illustrated) with long stirring shaft - With low inclusion of air 	<ul style="list-style-type: none"> - Hand-held unit with foldable impellers for stirring in closed drums 	<ul style="list-style-type: none"> - Screw fastening for mounting on bunghole 2" - Foldable impellers as for 028-0144 	<ul style="list-style-type: none"> - With clamping device for open containers - For circulating and stirring filled and unfilled resin systems 	<ul style="list-style-type: none"> - For circulating and stirring filled and unfilled laminating resins - Incl. container screw cap lid 	<ul style="list-style-type: none"> - The stirring process takes place without harmful entrainment of air and without undesired foam formation. - Because of the large mixing circle diameter and resulting low speed, the product is gently stirred - Container mixing tools are also available in an explosion-proof version









Vacuum Consumables



	Art. No.	Product name	Sales Arguments	Size	Unit
Vacuum bagging film					
	930-0905	PRO-VAC 100-LB-75	<ul style="list-style-type: none"> • A tough, high temperature resistant, co-extruded, nylon based material that was designed for use in the production of advanced composite structures such as wind turbine blades and nacelles for wind energy plants, boat hulls and decks as well as other industrial structures. • The film is suitable for use in both resin infusion and prepreg moulding processes and is resistant to all commonly used resin systems. • Not suitable for use in autoclave processes. • The normal thickness is 75 µ; other thicknesses available on request. • Maximum temperature 177 °C 	Available in widths 3, 4, 6, 8 and 10.5 m.	Roll
	930-0904	PRO-VAC 150-LG-75	<ul style="list-style-type: none"> • A tough, puncture resistant, co-extruded film made of polyolefin and nylon based resins that can be used for the production of polyester / vinyl ester resin infused components in the wind energy, marine and general composite industries. • Not recommended for use with epoxy resin systems. • Less sensitive in low humidity which is often problematical for predominantly nylon based films since a lack of moisture can reduce flexibility. This ensures consistent quality throughout the entire year in all working environments. • Maximum temperature 120 °C • Layer thickness 75 µ. For larger, more complex mouldings such as boat decks, we recommend the use of our 80 µ thick product since it is more resistant to stress during production and has higher tear strength. 	Available in widths 4, 6, 8 and 10 m.	Roll
	930-0902	PRO-VAC 150-LG-80	<ul style="list-style-type: none"> • Modified structure compared to our standard product PRO-VAC 150. Designed for the production of very large, complicated components such as boat decks where the film is subjected to significant stress. • Not recommended for use with epoxy resin systems. • Less sensitive in low humidity which is often problematical with predominantly nylon based films since a lack of moisture can reduce flexibility. This ensures consistent quality throughout the entire year in all working environments. • Layer thickness 80 µ • Maximum temperature 120 °C 	Available in widths 12 and 16 m	Roll
	930-0906	PRO-VAC 250-G-75GL	<ul style="list-style-type: none"> • This film was designed for the production of laminated safety glass. • The tough but flexible nylon film is ideal for applications in oven and autoclave processes for glass structures in conjunction with EVA or PVB interlayers. • Standard thickness is 75 µ; other thickness available, depending on requirements. • Maximum temperature 170 °C 	Available in widths 1.2 and 1.5 m.	Roll
	930-0907	PRO-VAC 200-O-50	<ul style="list-style-type: none"> • Highly flexible multi-layer nylon vacuum bagging film designed for use in the production of advanced composite structures and laminated safety glass. • The film is ideal for applications in oven and autoclave processes up to the maximum recommended temperature of 170 °C. • The decisive advantages of this film are its high elongation and high flexibility. • Layer thickness 50 µ 	Available in widths 1.5 and 2.2 m.	Roll
	930-0908	PRO-VAC 200-G-75	<ul style="list-style-type: none"> • Highly flexible multi-layer nylon vacuum bagging film designed for use in the production of advanced composite structures and laminated safety glass. • This film is ideal for applications in oven and autoclave processes up to the maximum recommended temperature of 170 °C. • The decisive advantages of this film are its high elongation and high flexibility. • Layer thickness 70 µ 	Available in widths 1.5 and 2.2 m.	Roll
Sealing tape					
	930-0750	BÜFA@-Tec Sealant Tape	A high quality sealant tape made of a mixture of butyl rubber. The dimensions and formulation of the product have been optimised to improve performance and facilitate use. The sealant tape is used in film processes in the composite industry.	3 mm x 15 mm x 15 m	Roll
Adhesive tape					
	930-0780	BÜFA@-Tec Tacky Glass Tape 27 mm	BÜFA@-Tec Tacky Glass Tape 27 mm is a 27 mm wide, glass fibre adhesive tape. It was designed for temporary fixation of reinforcement materials and can be used in the composite industry, particularly for RTM and infusion processes.	27 mm x 100 m	Roll

Vacuum Consumables

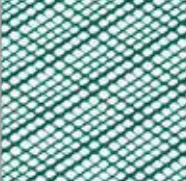

	Art. No.	Product name	Sales Arguments	Size	Unit
Perforated film/Release film					
	930-0915	PRO-VAC 500-B-28 Release film	<ul style="list-style-type: none"> For applications in infusion processes for the production of advanced composite structures. Suitable for a wide range of epoxy, polyester and vinyl ester resin systems. However, we recommend preliminary testing before producing large moulded parts in an infusion process. The film is available in a sky blue colour with perforation P31 (approx. 6 holes per cm²) for vacuum infusion and perforation P3 for liquid applications and prepregs. The perforations are not needed to ensure uniform impregnation of the entire laminate with resin. Other colours, thicknesses and perforation patterns are possible. Layer thickness 28 µ Maximum temperature 125 °C 	1.5 x 500 m	Roll
	930-0916	PRO-VAC 550-Y-50 Release film	<ul style="list-style-type: none"> Designed for applications in infusion processes used for the production of advanced composite structures. Suitable for a wide range of epoxy, polyester and vinyl ester resin systems. However, we recommend preliminary trials before producing large moulded parts in an infusion process. The film is available in a sky blue colour with perforation P31 (approx. 6 holes per cm²) for vacuum infusion and perforation P3 for liquid applications and prepregs. The perforations are not needed to ensure uniform impregnation of the entire laminate with resin. Other colours, thicknesses and perforation patterns are possible. Layer thickness 50 µ Maximum temperature 153 °C 	1.5 x 250 m	Roll
Spray Adhesive					
	022-0090	BÜFA®-Tec Spray Adhesive 008	BÜFA®-Tec Spray Adhesive 008 was designed especially for work with composite materials. The spray adhesive is used for bonding fabrics such as glass and carbon, core materials such as PVC and balsa and fixing tubes, spirals or flow media. Because of its composition, BÜFA®-Tec Spray Adhesive 008 is especially compatible with UPE, VE and epoxy resin systems.	650 ml, 1 piece	Spray adhesive
Peel Ply					
	930-0901	PRO-VAC N85 Nylon peel ply	<ul style="list-style-type: none"> Heat set to 85 g/m² and washed 6.6 nylon peel ply. Designed for hand lay-up and vacuum infusion processes. Has a red tracer as visible indicator to reduce the risk of leaving the peel ply on the laminate. The fabric produces a surface that makes sanding the laminate easier. We do not recommend using this product together with phenolic resins. 	1.52 x 100 m	Roll
	930-0909	PRO-VAC P85 Polyester peel ply	<ul style="list-style-type: none"> Designed for hand lay-up and vacuum infusion processes. Has an orange tracer as visible indicator to reduce the risk of leaving the peel ply on the laminate. The fabric produces a surface that makes sanding the laminate easier. This product can be used together with phenolic resins as well as all other standard resin systems, however, we recommend preliminary testing to assess compatibility. 	1.52 x 100 m	Roll
Resin flow medium					
	930-0652	PRO-VAC KM160E1 Resin flow medium	<ul style="list-style-type: none"> 3D knitted infusion mesh. Compatible with all standard epoxy, polyester and vinyl ester resin systems. Easy to drape – can be used for complex moulds. Can also be used as a reusable breather mat for compressing at room temperature. Density 160 g/m² Available up to 2 m wide. 	100 m	Roll
	930-0653	PRO-VAC BM230P Resin flow medium	<ul style="list-style-type: none"> Extruded infusion mesh. Due to of the stiffness of the material it is only recommended for plane panels and simply curved moulds. Compatible with all standard epoxy, polyester and vinyl ester resin systems. Density 230 g/m² A faster flowing mesh compared to knitted mesh. 	50 m	Roll

Vacuum Consumables



	Art. No.	Product name	Sales Arguments	Size	Unit		
Breather fabric							
	930-0676	PRO-VAC B-150 Breather fabric	<ul style="list-style-type: none"> Moderately heavy PET breather/extraction mat. Easy to drape – well suited for simply curved and complex components. Highly suitable for all low pressure production processes; can also be used in several layers to increase ease of flow. Density 150 g/m². Layer thickness at 2 kPa is 1.8 mm. Maximum temperature 170 °C 	1.52 x 95 m	Roll		
Connector							
			Material	Max. temperature			
	930-0960	PRO-VAC T-Connector PVT-10	PE	100 °C	10 mm Piece		
	930-0961	PRO-VAC T-Connector PVT-12	PE	100 °C	12 mm Piece		
	930-0962	PRO-VAC T-Connector PVT-18	PE	100 °C	18 mm Piece		
Spiral hose							
			Material	Max. temperature			
	930-0931	PRO-VAC Spiral hose PVS-10	PE	100 °C	10 mm x 100 m Roll		
	930-0930	PRO-VAC Spiral hose PVS-12	PE	100 °C	12 mm x 100 m Roll		
	930-0932	PRO-VAC Spiral hose PVS-18	PE	100 °C	18 mm x 100 m Roll		
Hose							
			Material	Di (+/-) / thickness (+/-) [mm]	Max. temperature	Length (m)	
	930-0933	PRO-VAC Infusion hose PVI-10	PE	10 (+/- 0.5) / 1.0 (+/- 0.1)	100 °C	100	10 mm x 100 m Roll
	930-0934	PRO-VAC Infusion hose PVI-12	PE	12 (+/- 0.5) / 1.0 (+/- 0.1)	100 °C	100	12 mm x 100 m Roll
	930-0936	PRO-VAC Reinforced hose PV-RHOSE-13	PVC fibre reinforced	13/5.0	60 °C	100	13 mm x 100 m Roll
	930-0937	PRO-VAC Reinforced hose PV-RHOSE-19	PVC fibre reinforced	19/5.0	60 °C	50	19 mm x 50m Roll
	930-0938	PRO-VAC Reinforced hose PV-RHOSE-18	PVC spiral reinforced	18/2.5	60 °C	50	18 mm x 50m Roll

Vacuum Consumables



	Art. No.	Product name	Sales Arguments			Size	Unit
Accessories							
			Material	Di (+/-) / height [mm]	Max. temperature		
	930-0970	PRO-VAC Inlet Block PVINB-16	PP	16 (+/- 0.5) / 35	100 °C	16 mm	Piece
			Material	Da (mm)	Max. temperature		
	930-0971	PRO-VAC L-Connector for Inlet Block PVL-12	PE	12	100 °C	12 mm	Piece
	930-0972	PRO-VAC L-Connector for Inlet Block PVL-18	PE	18	100 °C	18 mm	Piece
			Material	Di (mm)	Max. temperature	Length (m)	
	930-0973	PRO-VAC Omega channel PVO-16	PVC	16	60 °C	4	16 mm Piece
			Material	Da (mm)	Max. temperature		
	930-0980	PRO-VAC Infusion valves PVV-10 double O-ring	PE	10	100 °C	12 mm	Piece
	930-0981	PRO-VAC Infusion valves PVV-12 double O-ring	PE	12	100 °C	12 mm	Piece
	930-0982	PRO-VAC Infusion valves PVV-18 double O-ring	PE	18	100 °C	18 mm	Piece



Tools and Ancillaries

Filling out of the drum	
Art. No.	Products
026-8310	Drum plug wrench
026-8302	Drum tap 2"

Metering of resins and pigment pastes with stable measuring cups in BÜFA quality made of polyethylene	
Art. No.	Products
026-2705	Measuring cup 500 ml
026-2710	Measuring cup 1000 ml
026-2720	Measuring cup 2000 ml

Venting with PTFE rollers for continuous use - durable and easy to clean	
Art. No.	Size
026-5482	8 x 80 mm
026-5442	8 x 40 mm
026-5980	Corner roller 50 x 8 mm
026-5612	14 x 100 mm

Metering of hardeners and accelerators	
Art. No.	Products
026-2810	PE measuring cylinder 100 cm
026-2805	PE measuring cylinder 50 cm
026-2909	Hardener metering attachment „Max“
026-2908	2000 ml bottle for hardener metering device

Venting with metal disc rollers	
Art. No.	Products
026-5102	Flex Roller (adapts to contours)
026-5011	Metal disc roller 12 x 80 mm
026-5005	Metal disc roller 12 x 40 mm
026-5101	Metal Corner roller 45 x 10 mm



Venting with polypropylene rollers - the cost-effective alternative	
Art. No.	Size
026-5335	28 x 180 mm
026-5481	10 x 80 mm
026-5441	10 x 40 mm
026-5981	Corner roller 40 x 8 mm
026-5611	14 x 100 mm
026-5681	14 x 80 mm
026-5641	14 x 40 mm

Impregnating	
Art. No.	Products
026-6710	Nylon roller on one side
026-6811	Handle on one side
026-7246	Nylon roller 18 cm
026-7204	Handle 18 cm
026-0730	Modler 3" 7.5 cm
026-0720	Modler 2" 2 cm

Industrial safety and hygiene	
Art. No.	Products
026-8932	Fine dust safety mask 8710E
026-8933	Respiratory protection face mask 4251 for protection against solvent vapours (Boiling point > 65 °C)
026-8991	Clear plastic glasses
026-8401	Lined cotton gloves Size 9-10

Large selection but limited space!

Our tool and auxiliary equipment programme has a lot more to offer than we could possibly show on this page. So just ask us! We have the solution!



Do you need a system that is especially produced for you and takes your needs into account?

Then BÜFA Tec machine technology is exactly right for you!

Our engineers and technicians design, deliver and install solutions that are tailor-made for your requirements.

- Special systems
- Tanks, containers
- Material supply
- Stirring and dispersing technology
- Filling level and flow monitoring systems for reproducible and optimised processes
- Process data visualisation as well as long-term recording
- Integral application systems

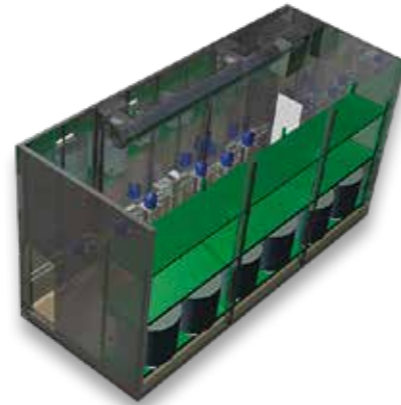

Examples:



Plant construction and installation



Resin tank and mixer



Peroxide tank with level control



Every production process has different requirements and therefore also different service needs.

Type and age of the system, spraying or laminating output as well as the number of trained employees are just a few examples that influence the scope of services.

You can rely on receiving support that is perfectly tailored to your needs by our BÜFA Tec team!

You can choose yourself!

You decide on the scope of services that will cover your present needs and together we will determine the costs that will arise for service:

- Support of the system during the entire utilisation period.
- Inspection and maintenance of the system by our service technician (depending on operating hours once or twice a year).
- Replacement of parts subject to wear (e.g. pump packings and seals) followed by a functionality check.
- Optimisation of machine settings to reduce emissions and overspray.
- Professional project consulting by our engineers and technicians.
- Training of your employees, focusing on machine handling, maintenance and repair.

Give us a call! We'd be glad to help you: Phone +49 4402 975-0



BÜFA – Your Toll Manufacturer

Save time, money and resources.



Let our specialists do your manufacturing!



Are you looking for a toll manufacturer with a qualified team that is specialised in the production and packaging of liquid products / pastes – and, of course, in the highest standard?

Look no longer ...

Our decades of experience in the field of specialities made of polyester, vinyl ester and epoxies as well as the latest machine technology exactly meet these criteria.

With our mixing equipment, we can disperse and homogenise batch sizes from 0.5 - 20 m³.

That gives us a high degree of flexibility and allows us to keep delivery dates.

A high safety standard and high quality demands are a matter of course for us.

Give us a call and try us out ...
Herr Peter Schiffer Phone +49 4402 975-335

Premium Partners



The information given above is based on our current state of knowledge and experience. In view of the many factors that may influence working conditions and application, the user is not relieved from carrying out his own tests and trials. No legally binding warranty of certain properties or suitability for a particular purpose can be derived from this information. It is the responsibility of the receiver or user of our products to

observe proprietary rights as well as existing laws and regulations. The latest version of the EU Safety Data Sheet must also be observed.

For Technical Data Sheets and information, go to www.buefa.de.

Some of our customer references





**SYSTEM SOLUTIONS
AS WELL AS
INNOVATIVE AND
TAILOR-MADE
COMPOSITE
MATERIALS FOR:**

- Rail Vehicle
- Transportation
- Automotive
- Wind Energy
- Marine
- Cruiser
- Swimming Pools
- Sanitary
- Building
& Construction
- Tanks & Pipes

BÜFA

Composites

BÜFA Composite Systems GmbH & Co. KG
Hohe Loohe 2-8
26180 Rastede
GERMANY

Phone +49 4402 975-0
compositesystems@buefa.de
www.buefa.de

A member of the BÜFA Group

